



## ARMO-A

### Smoke and Heat Exhaust Fans



Smoke and Heat Exhaust Fans (SHEF) provides to evacuate the toxic gases which have been gained momentum by the Jet Fans, from car park to atmosphere. SHEF are the same high temperature resistant values as Jet Fans. SHEF are mounted as vertical or horizontal according to characteristics of structure.

### Technical Descriptions



#### General Specifications

- Tested and certified in accordance with EN 12101 – 3 and CE.
- Ensured non – stop operation at elevated temperatures of 300°C and 400°C for 2 hours respectively.
- Different fan dimensions from 400 to 1250 mm.

#### Rotor Specifications

- High temperature resistant aluminium alloy casting blades and hub.
- Rotors can operate uni – directional and fully – reversible. Blades are specially designed for each direction type and have airfoil structure which has high aerodynamic performances.
- Fully – reversible blades can provide same thrusts for each type of directions.
- Pitch angle is adjustable thus different pressures and flow rates can be provided for the requirements.
- The fan wheel is dynamically balanced in accordance with ISO 1940.
- The hub is specially designed.

#### Casing Specifications

- All casings are sheet steel with a corrosion resistant hot dipped galvanized finish.
- In addition to standard long – cased fans, the short – cased version is also available for limited installation spaces.

#### Motor Specifications

- 2, 4 and 6 pole motors available
- IP 55 protection class
- Class – H insulation
- All electrical motors approved for “Running Continuously (S1)” or “Emergency Operation (S2)”.

#### Easy to Maintain

- On Request: Long casing fans with inspection hatch to ease the maintenance.

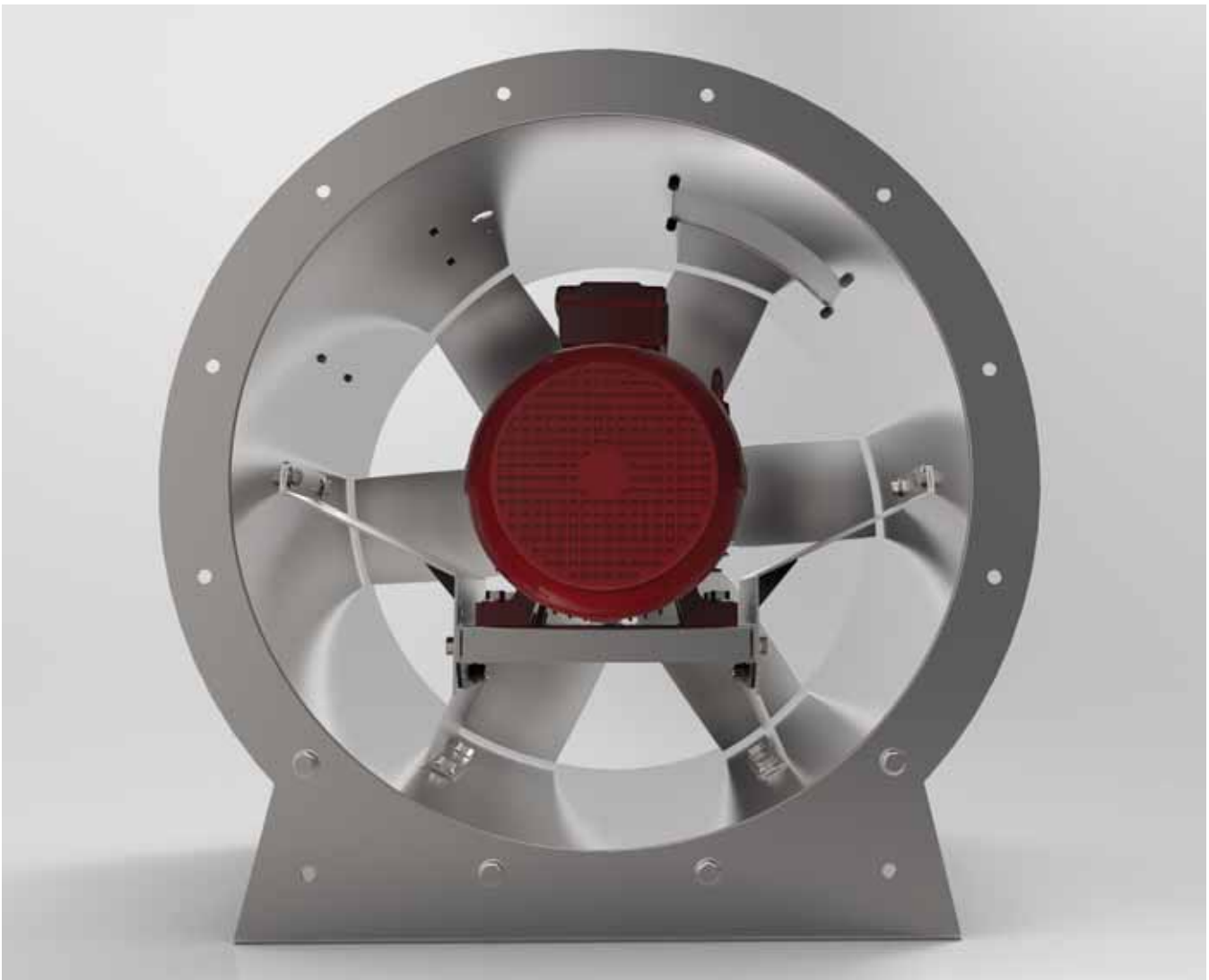

- DUCT FANS
- ROOF FANS
- AXIAL FANS
- RADIAL FANS
- PLASTIC FANS
- VENTILATORS
- SMOKE EXHAUST SYSTEMS
- ACCESSORIES

# SMOKE AND HEAT EXHAUST VENTILATION SYSTEMS

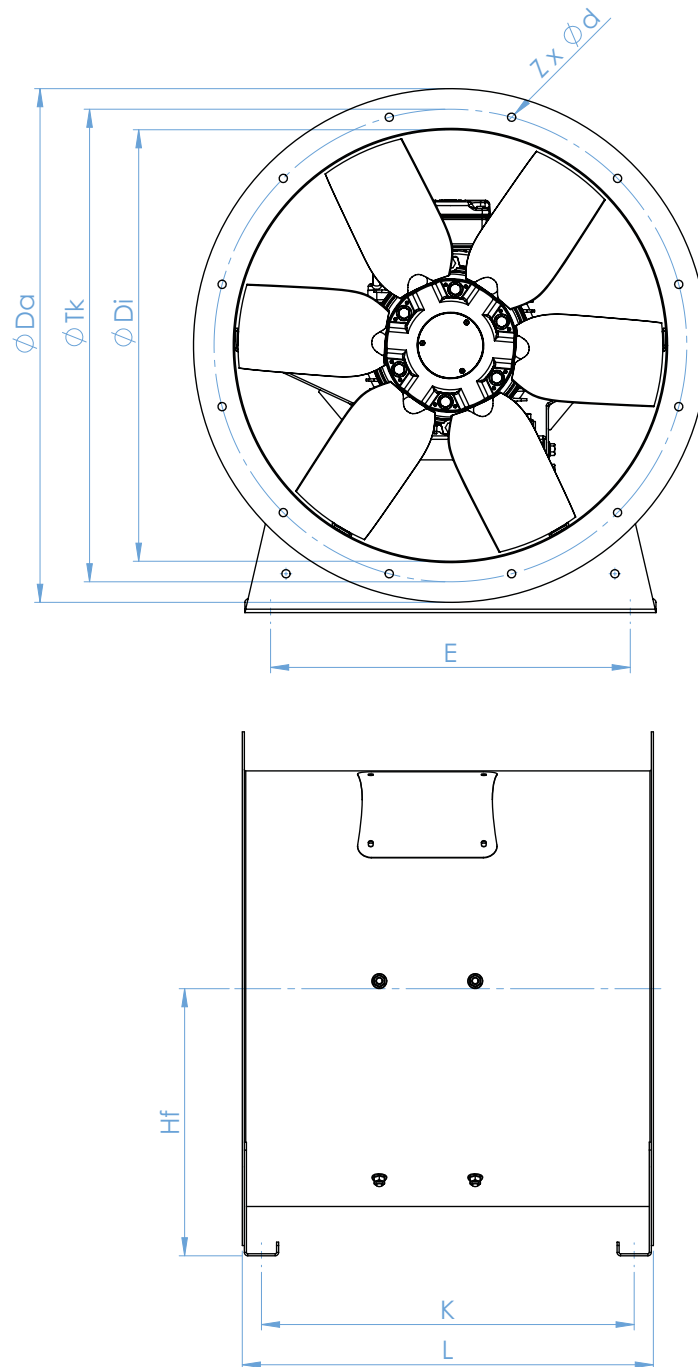

TYPE	ØDi	ØDa	ØTk	ZxØd	L	Hf	K	E
ARMO-A400-UL	400	500	450	8xØ12	450	225	400	320
ARMO-A450-UL	450	550	500	8xØ12	450	250	400	370
ARMO-A500-UL	500	620	560	12xØ12	550	290	500	410
ARMO-A560-UL	560	680	620	12xØ12	550	350	500	460
ARMO-A630-UL	630	750	690	12xØ12	600	400	544	525
ARMO-A710-UL	710	830	770	16xØ12	650	425	590	560
ARMO-A800-UL	800	920	860	16xØ12	700	485	624	630
ARMO-A900-UL	900	1040	970	16xØ15	800	525	720	730
ARMO-A1000-UL	1000	1140	1070	16xØ15	850	595	772	830
ARMO-A1120-UL	1120	1260	1190	20xØ15	950	650	860	850
ARMO-A1250-UL	1250	1390	1320	20xØ15	1050	720	950	900

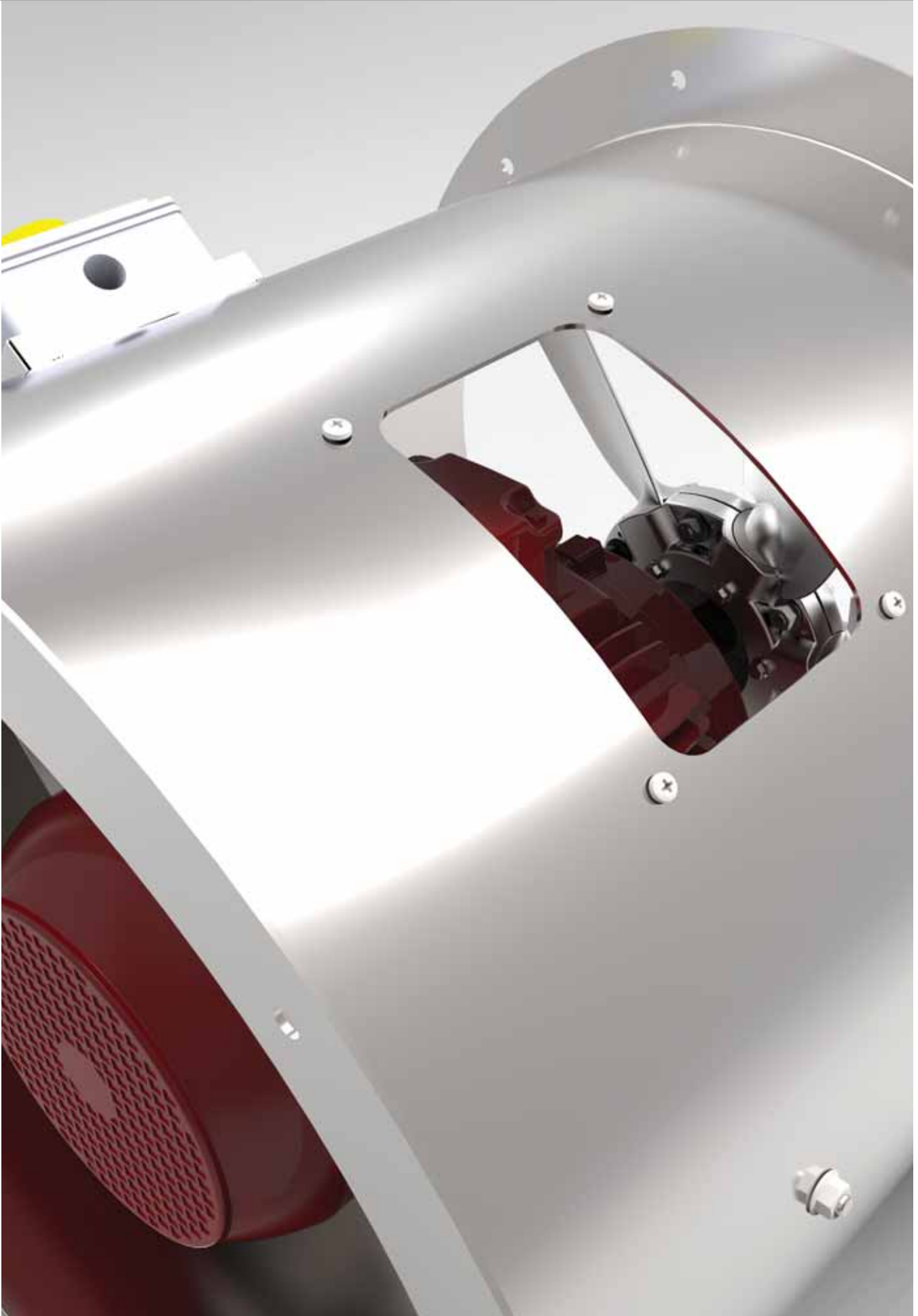

DUCT FANS

ROOF FANS

AXIAL FANS

RADIAL FANS

PLASTIC FANS

VENTILATORS

SMOKE EXHAUST SYSTEMS

ACCESSORIES



# SMOKE AND HEAT EXHAUST VENTILATION SYSTEMS

ARMO-A400/6/2A

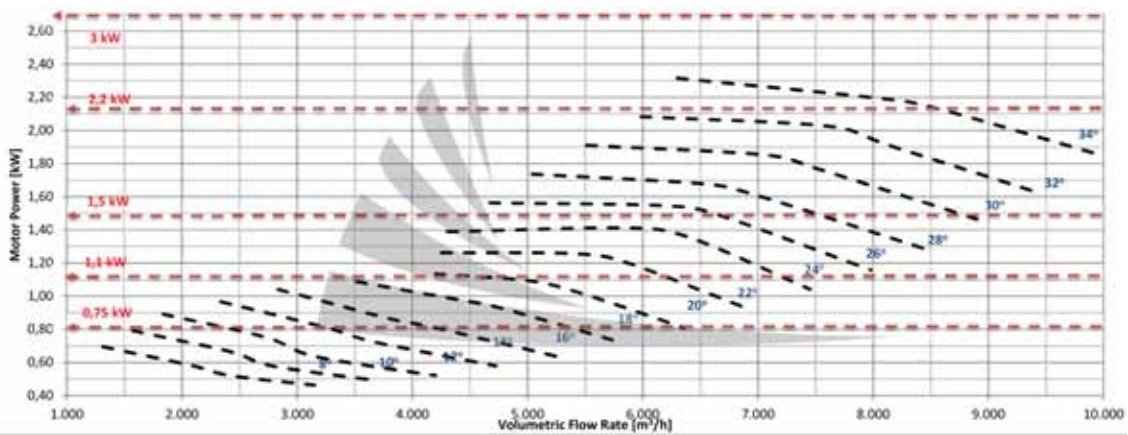
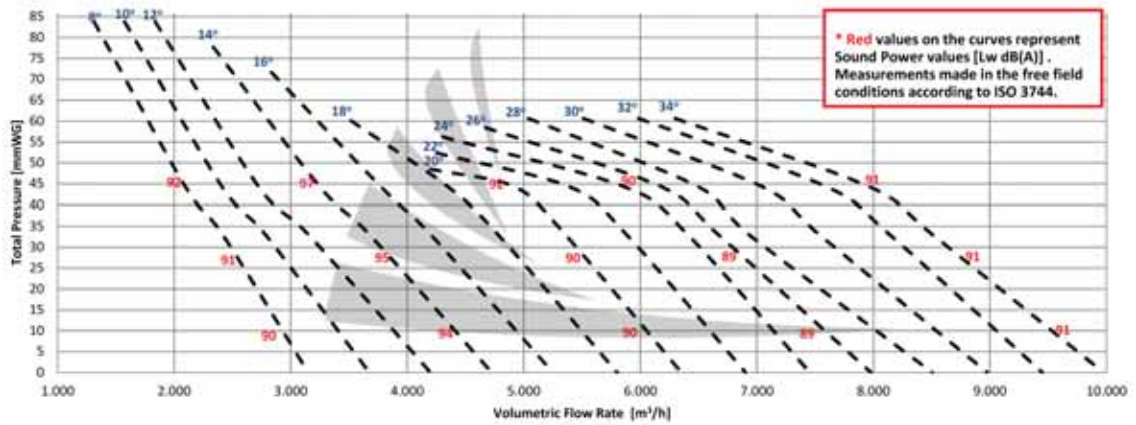

ARMO-A450/6/2A

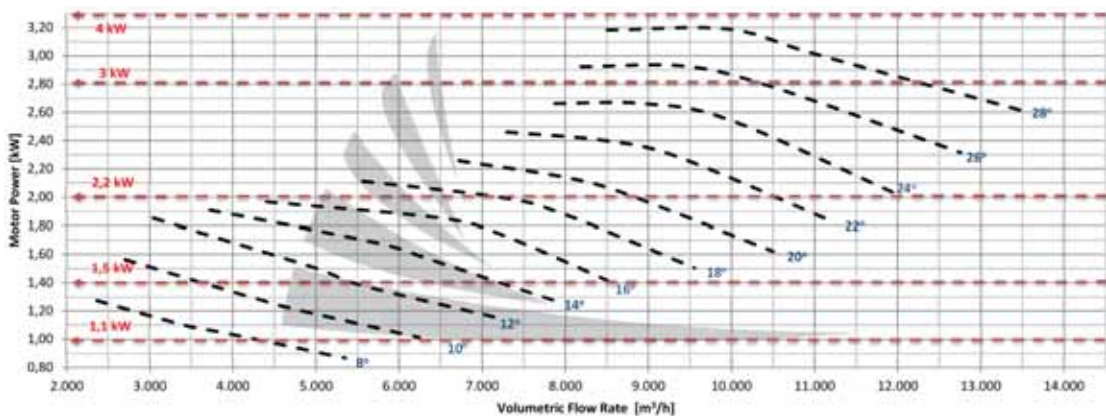
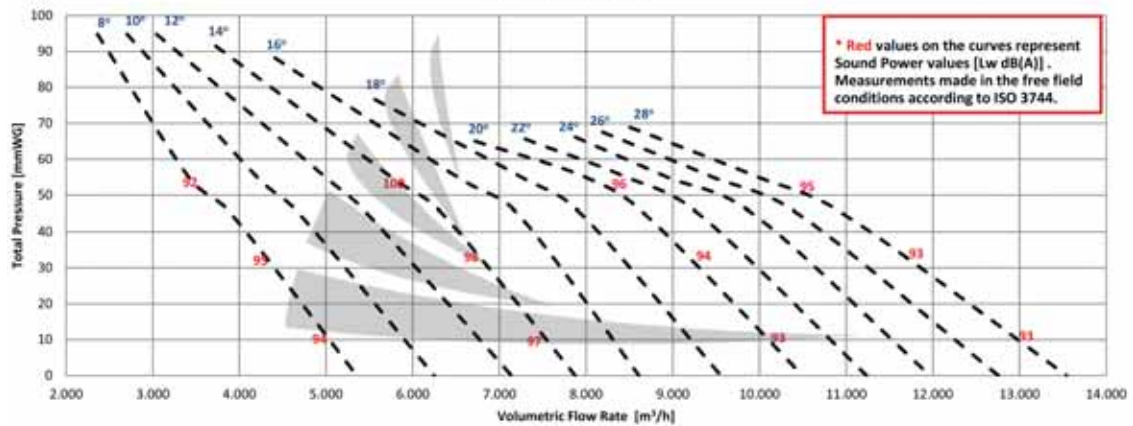

### ARMO-A500/6/2A

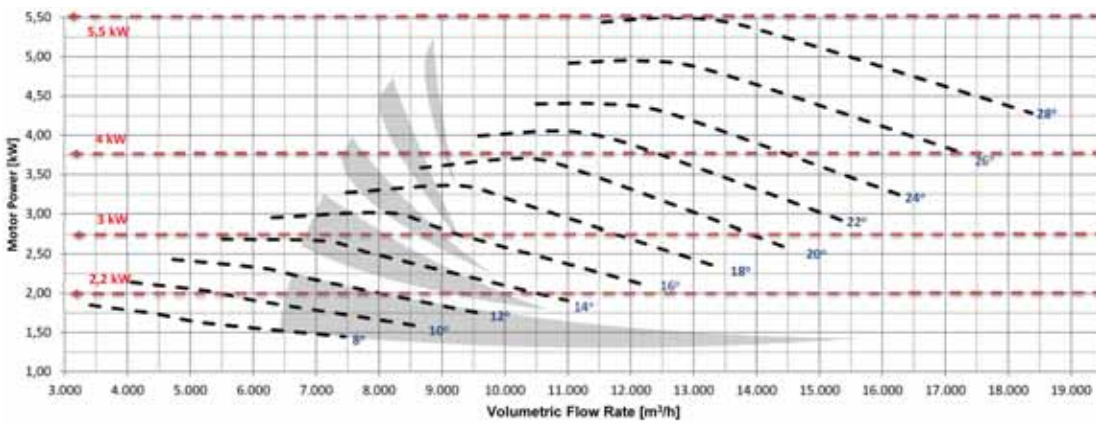
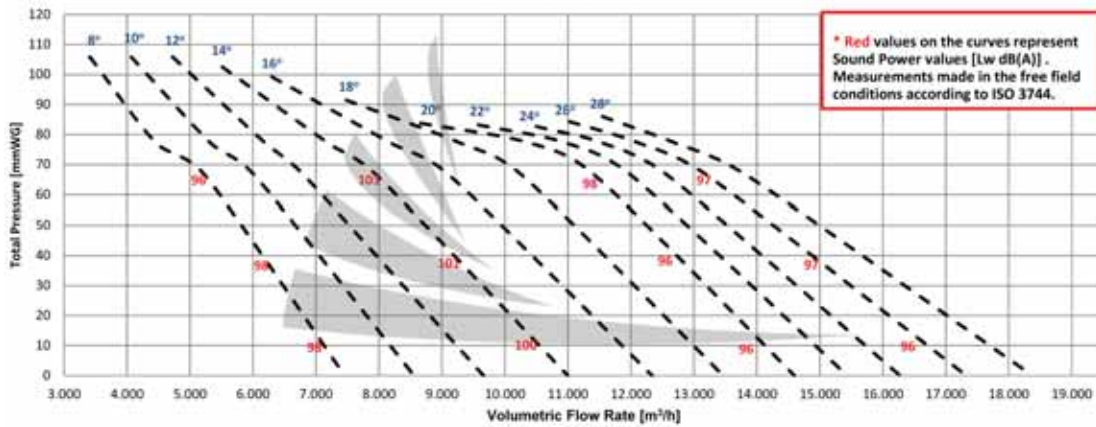

### ARMO-A560/6/2A

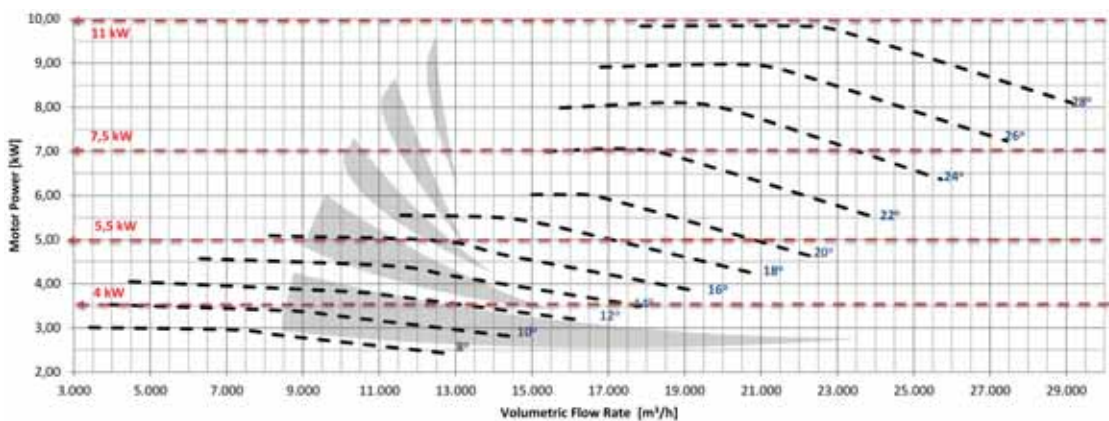
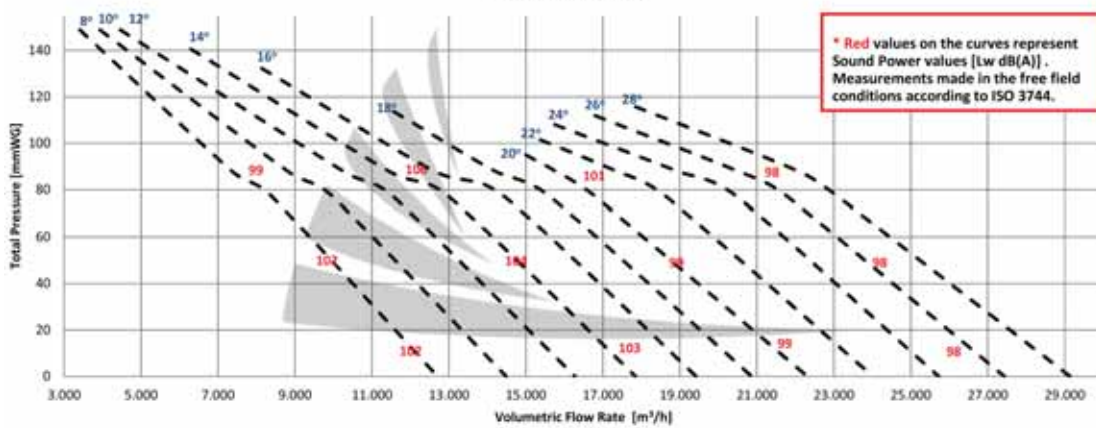

DUCT FANS

ROOF FANS

AXIAL FANS

RADIAL FANS

PLASTIC FANS

VENTILATORS

SMOKE EXHAUST SYSTEMS

ACCESSORIES



# SMOKE AND HEAT EXHAUST VENTILATION SYSTEMS

ARMO-A630/6/2A

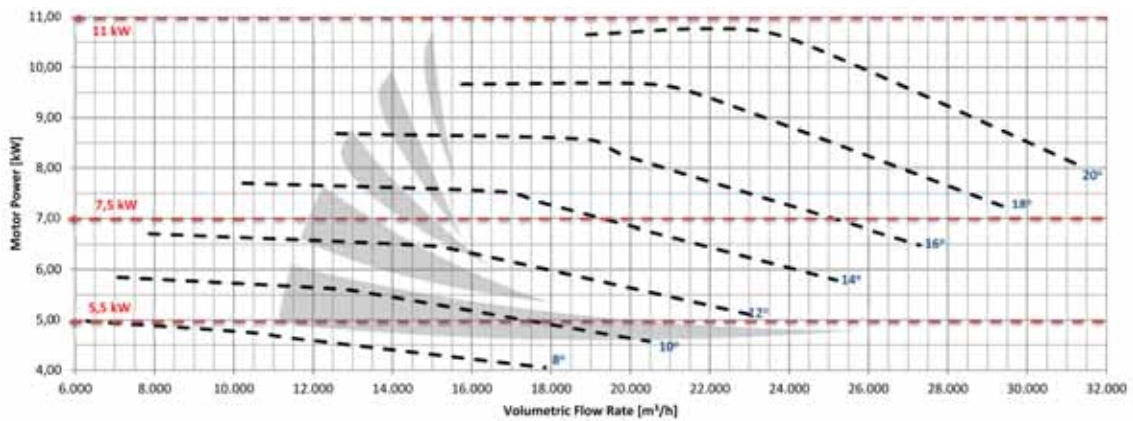
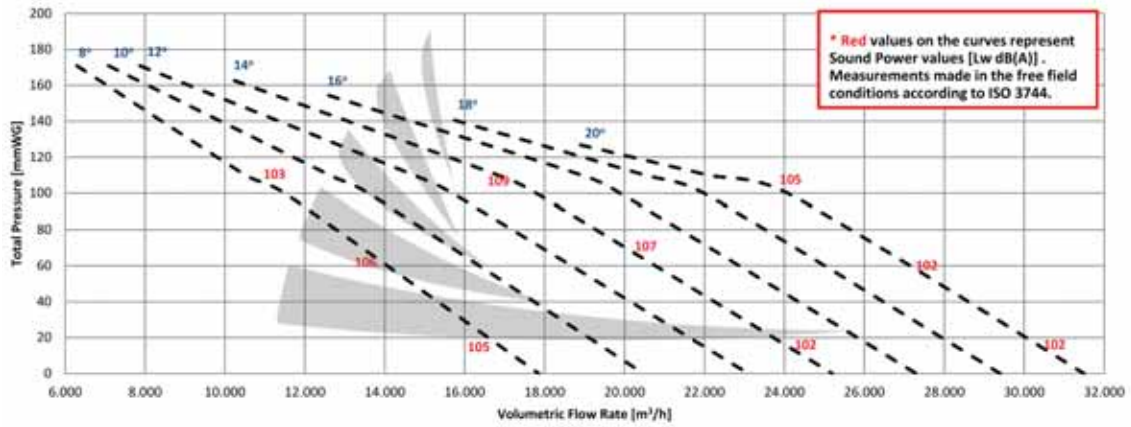

ARMO-A500/6/4A

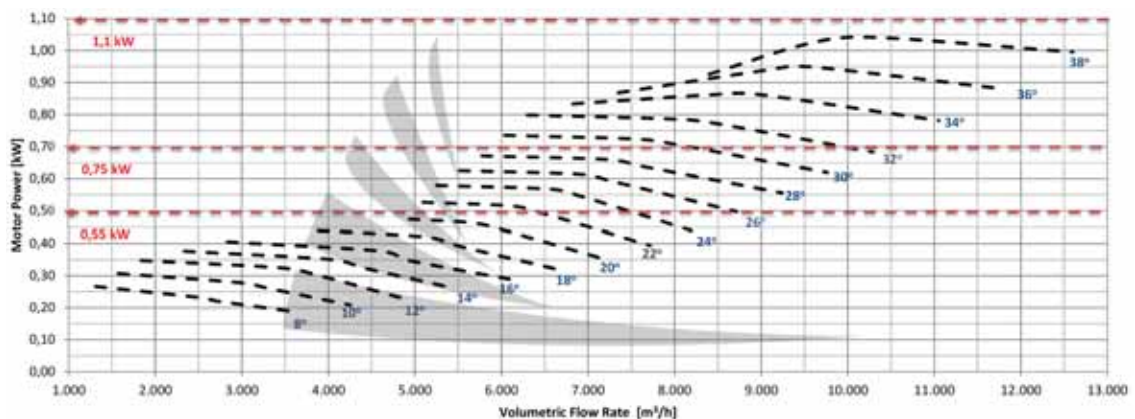
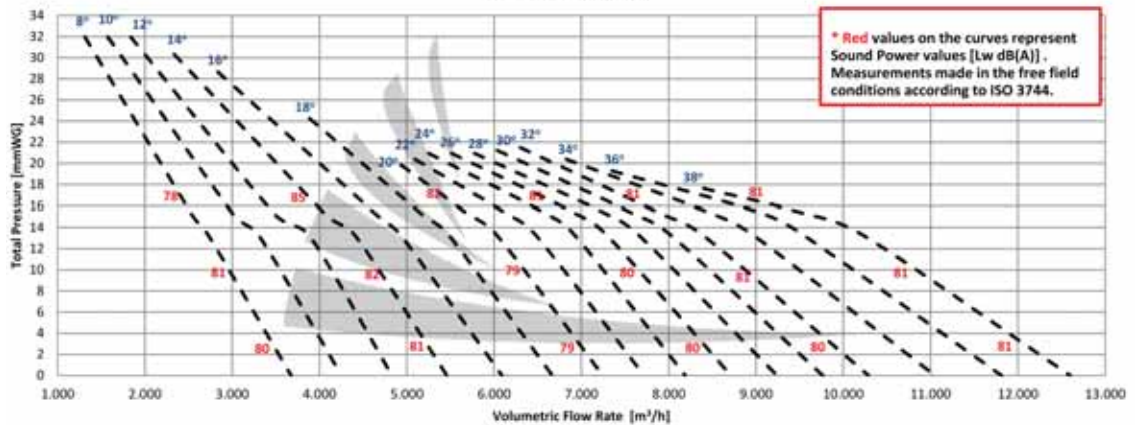

### ARMO-A560/6/4A

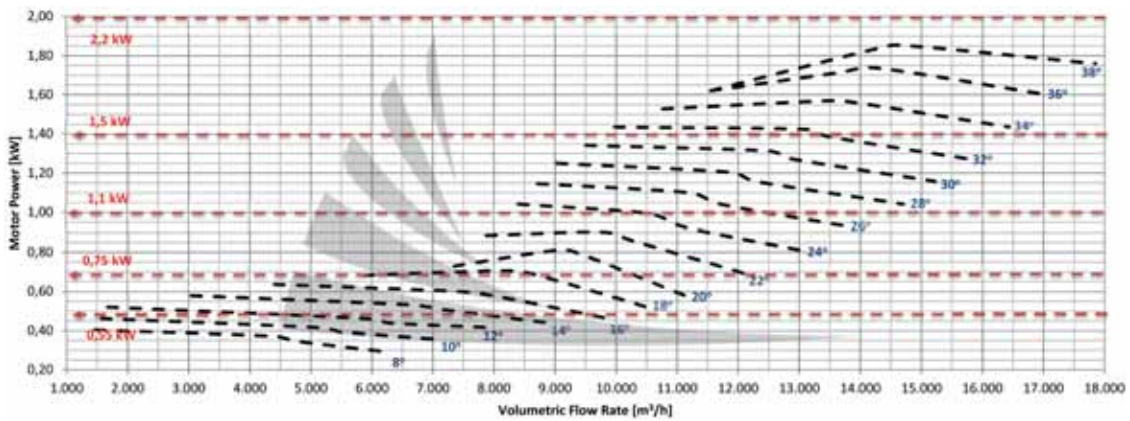
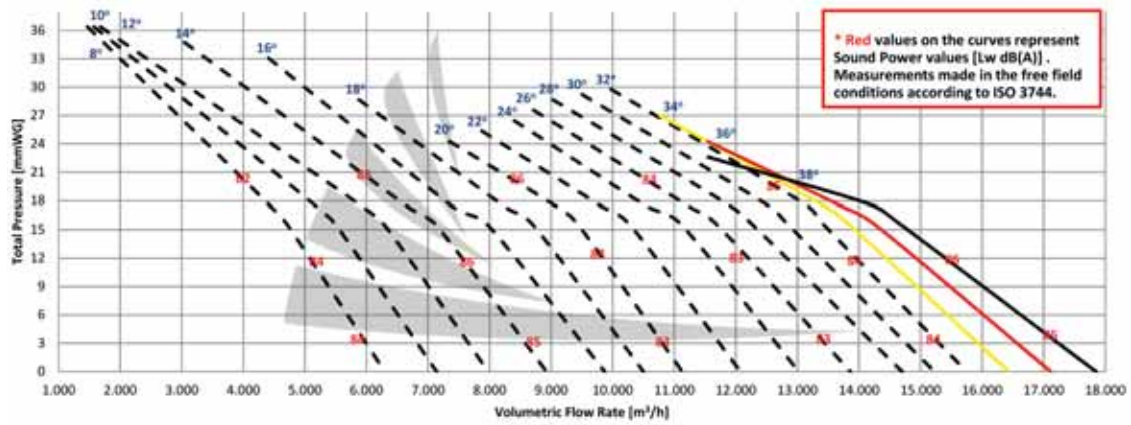

### ARMO-A630/6/4A

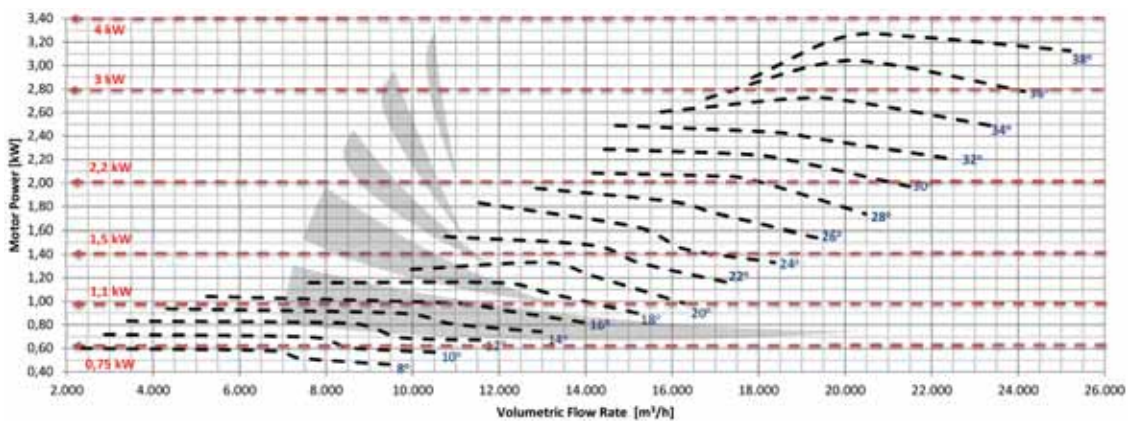
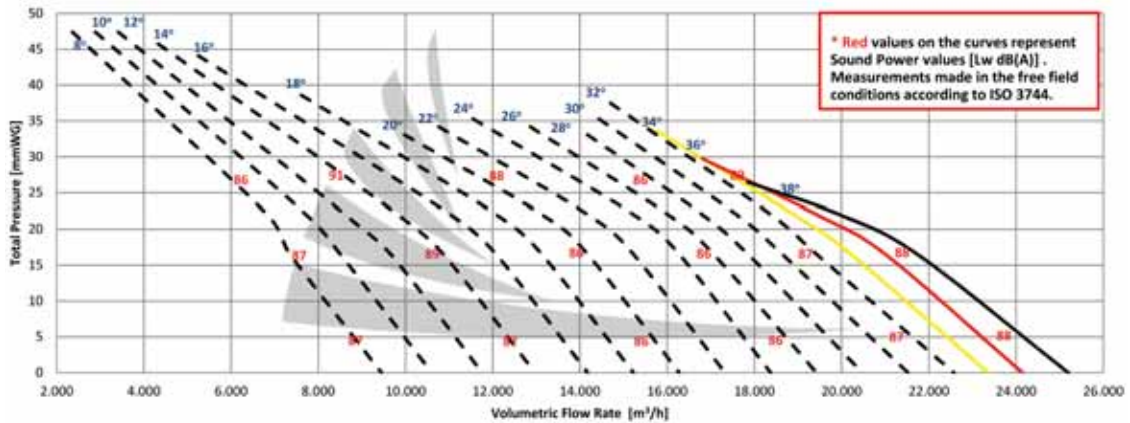

DUCT FANS

ROOF FANS

AXIAL FANS

RADIAL FANS

PLASTIC FANS

VENTILATORS

SMOKE EXHAUST SYSTEMS

ACCESSORIES



# SMOKE AND HEAT EXHAUST VENTILATION SYSTEMS

ARMO-A710/3/4A

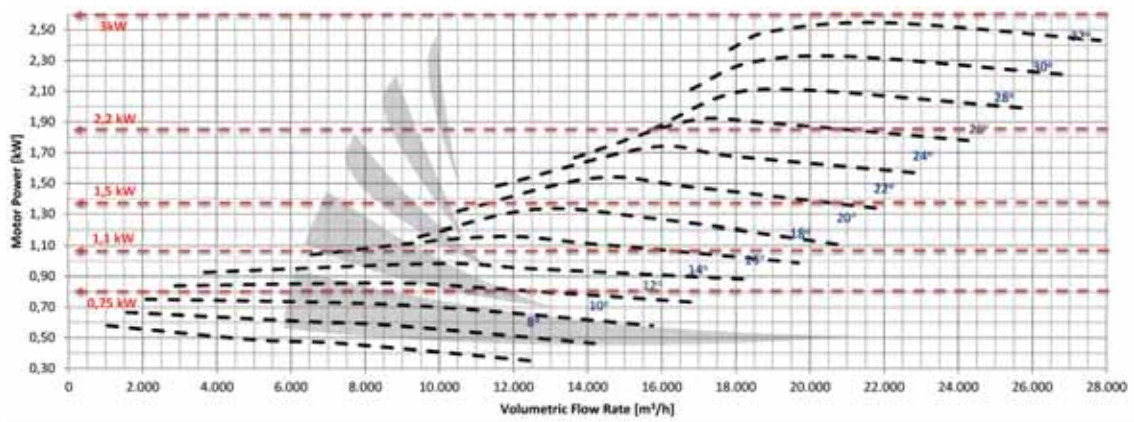
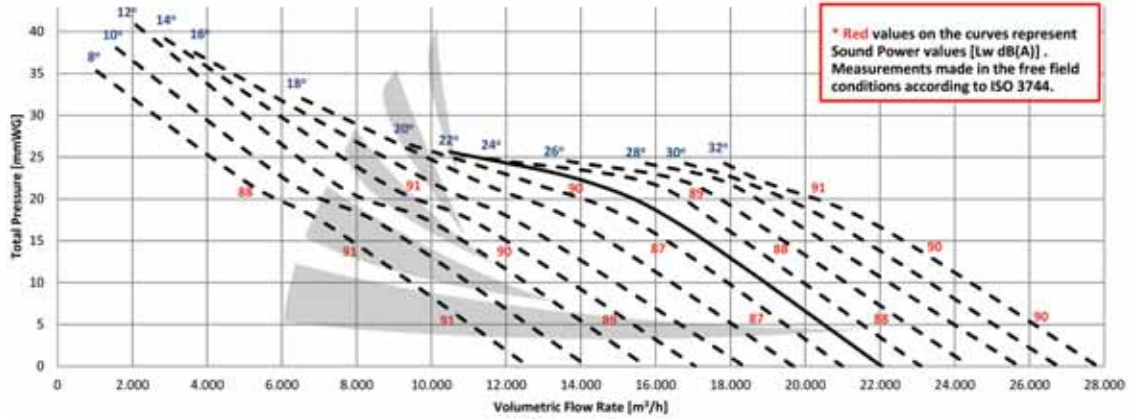

ARMO-A710/6/4A

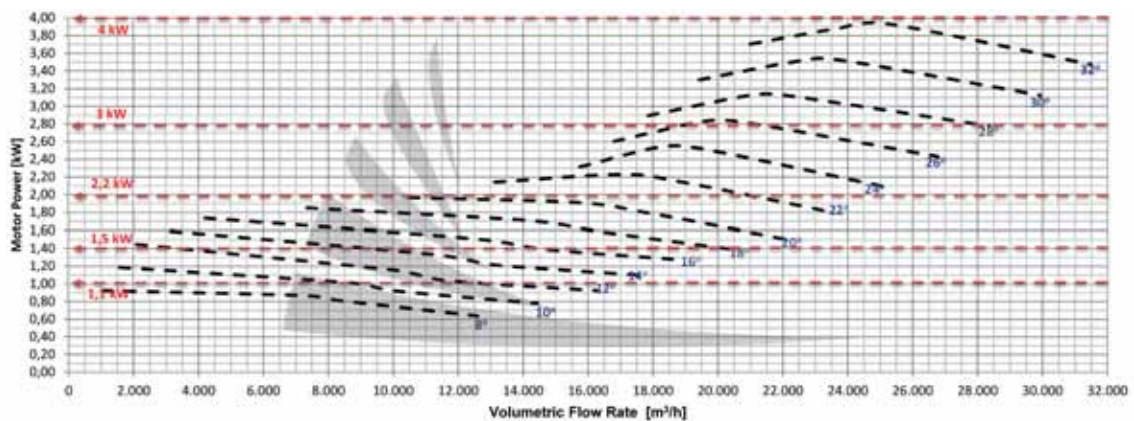
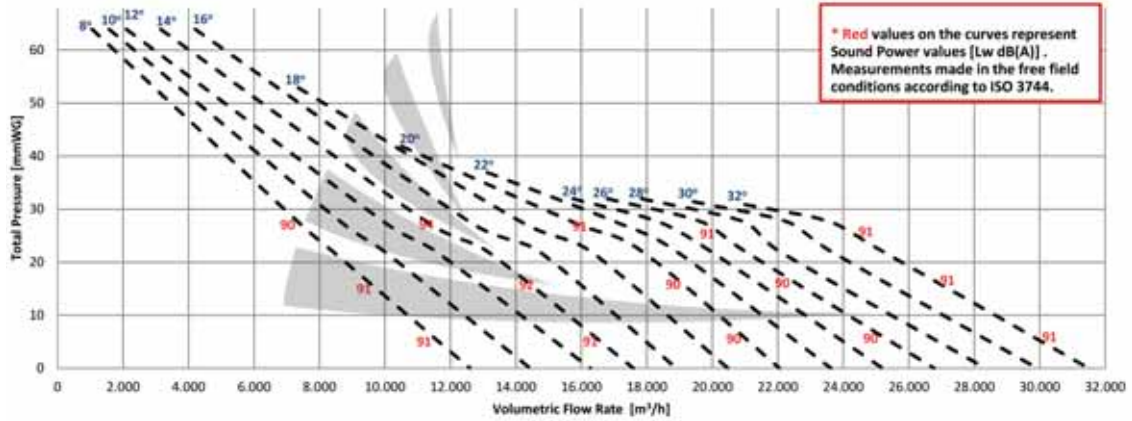

### ARMO-A800/6/4A

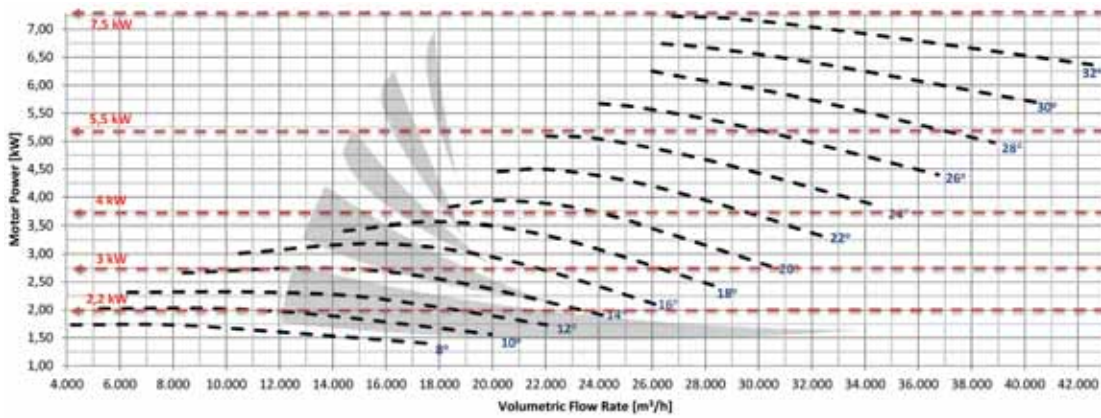
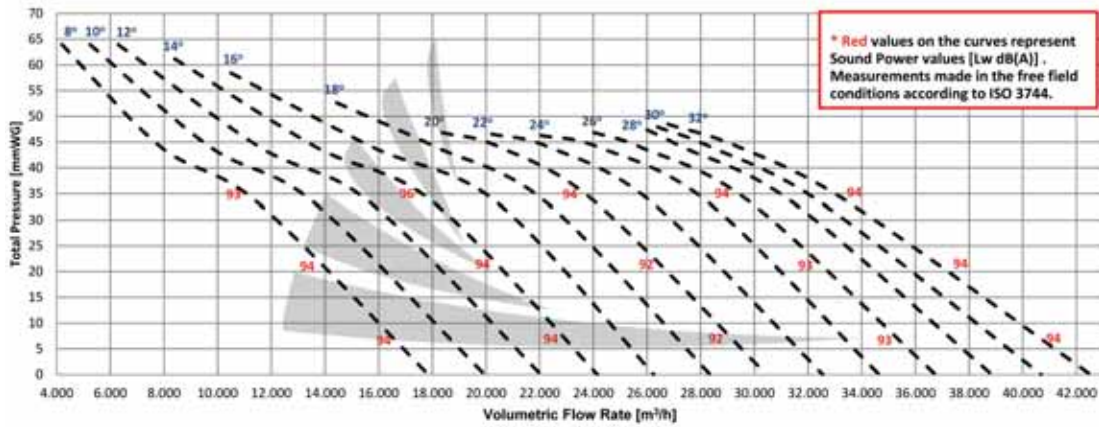

### ARMO-A800/9/4A

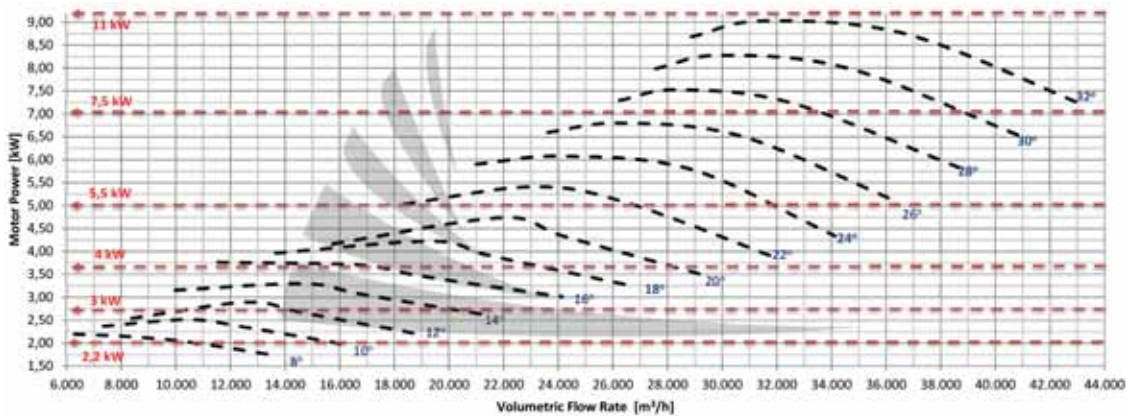
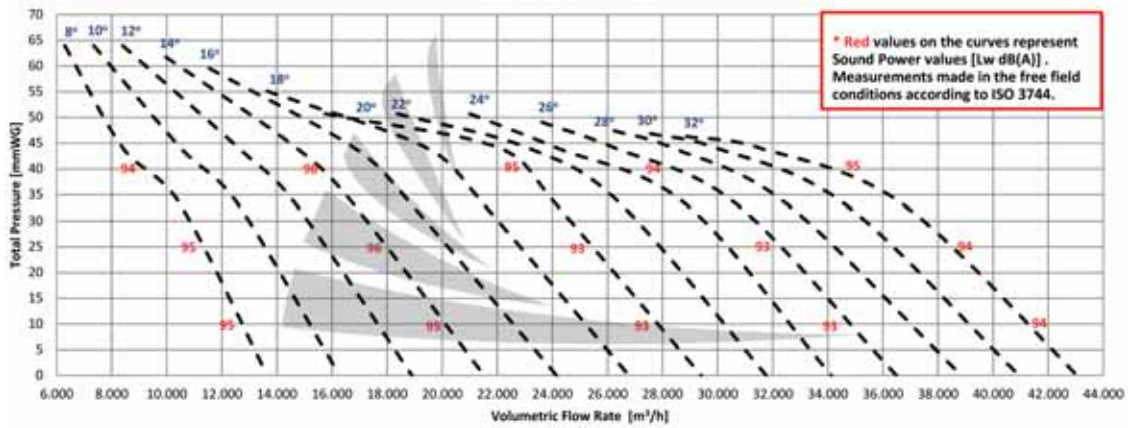

DUCT FANS

ROOF FANS

AXIAL FANS

RADIAL FANS

PLASTIC FANS

VENTILATORS

SMOKE EXHAUST SYSTEMS

ACCESSORIES



# SMOKE AND HEAT EXHAUST VENTILATION SYSTEMS

ARMO-A900/6/4A

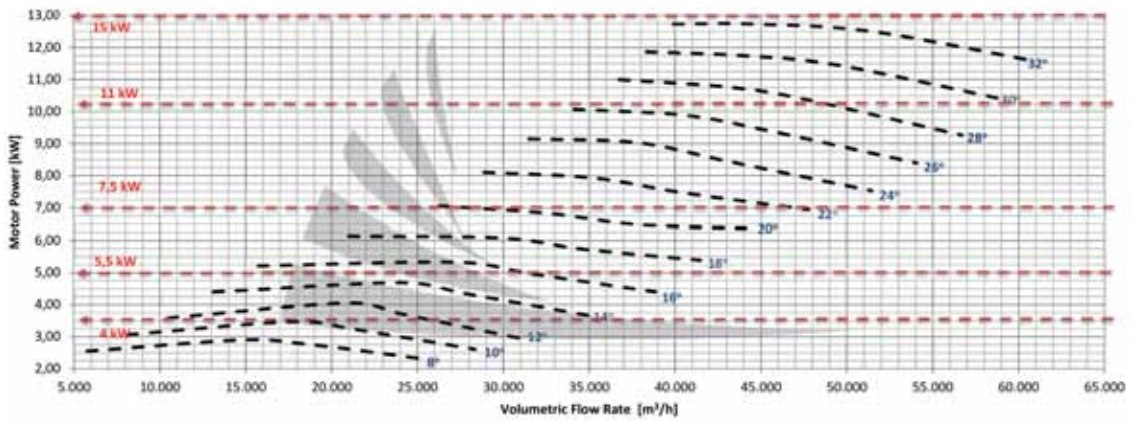
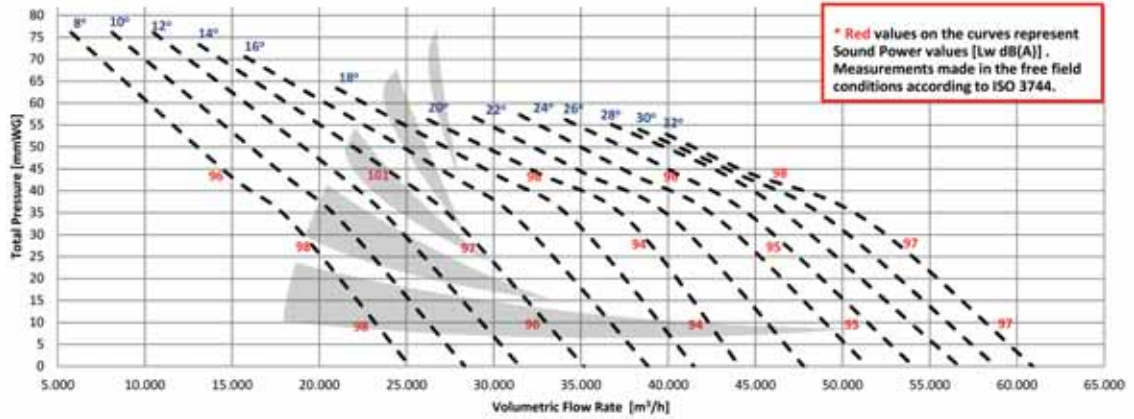

ARMO-A900/9/4A

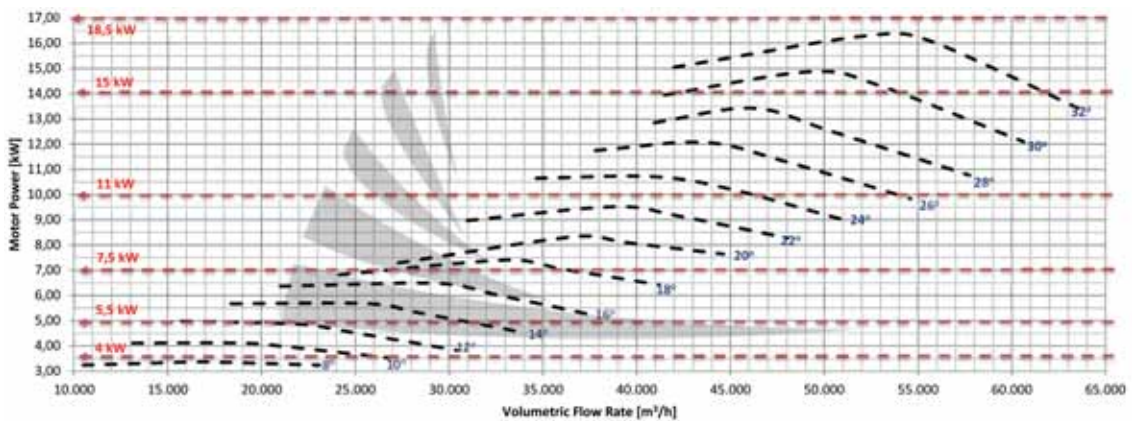
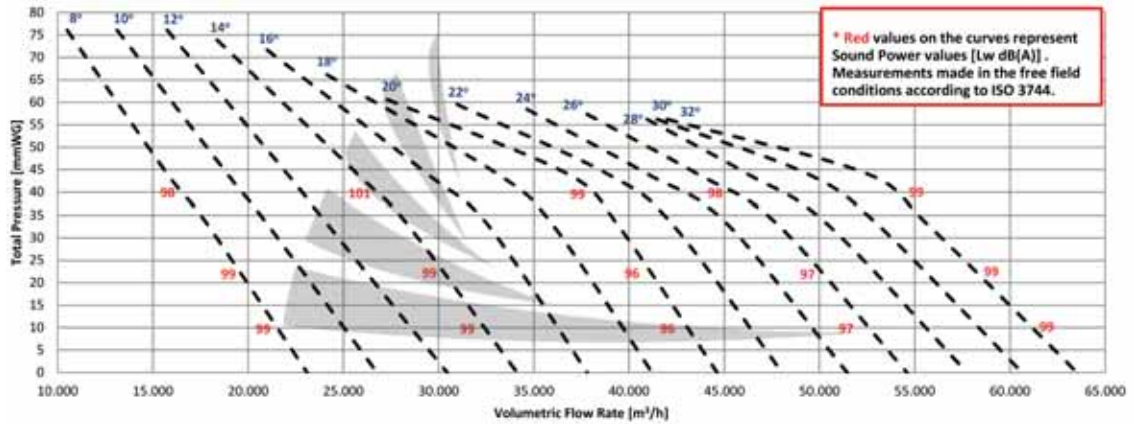



### ARMO-A1000/6/4A

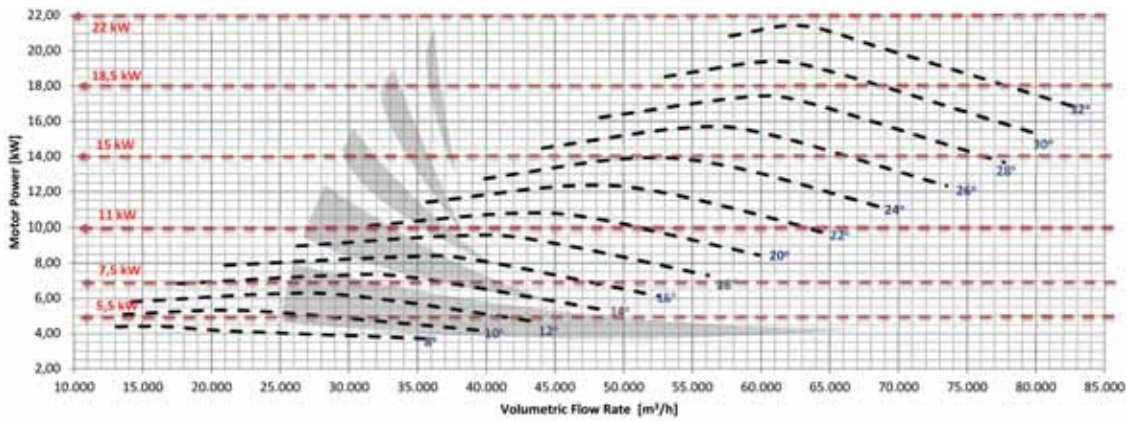
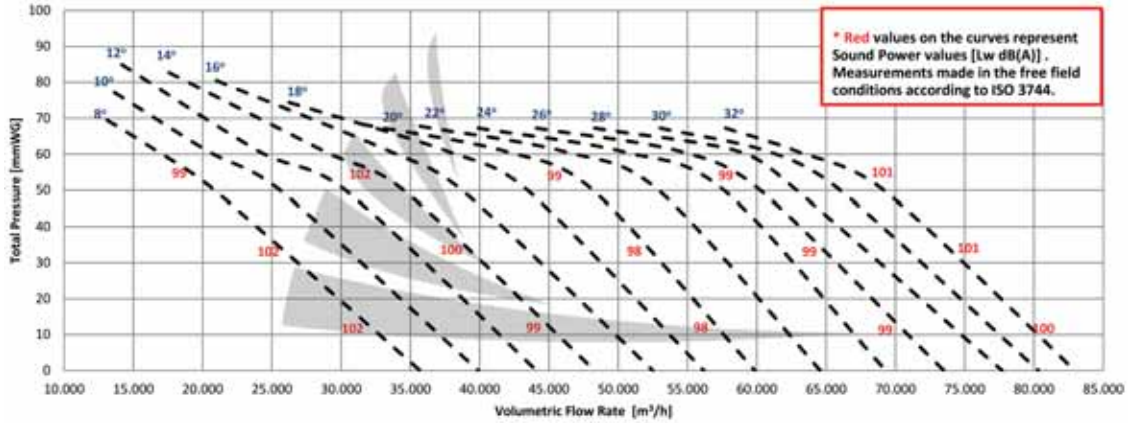

### ARMO-A1000/9/4A

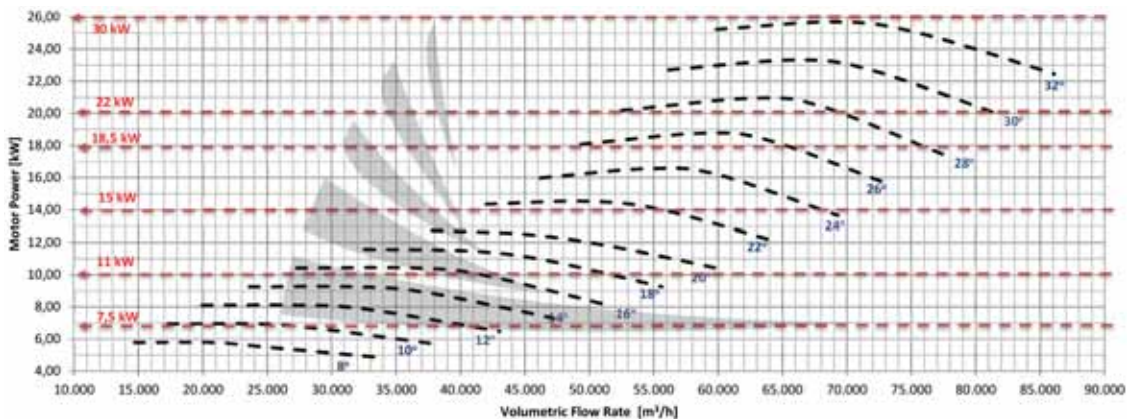
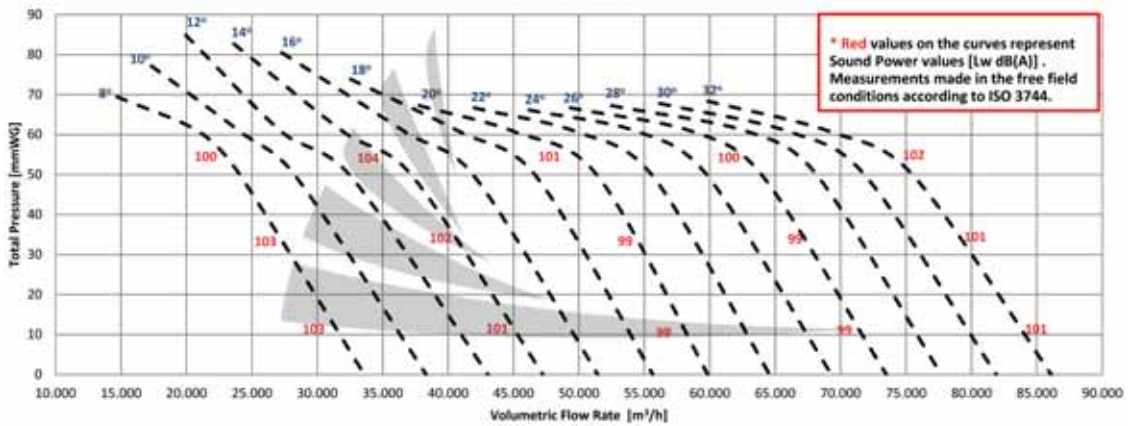

DUCT FANS

ROOF FANS

AXIAL FANS

RADIAL FANS

PLASTIC FANS

VENTILATORS

SMOKE EXHAUST SYSTEMS

ACCESSORIES

# SMOKE AND HEAT EXHAUST VENTILATION SYSTEMS

ARMO-A1250/6/4A

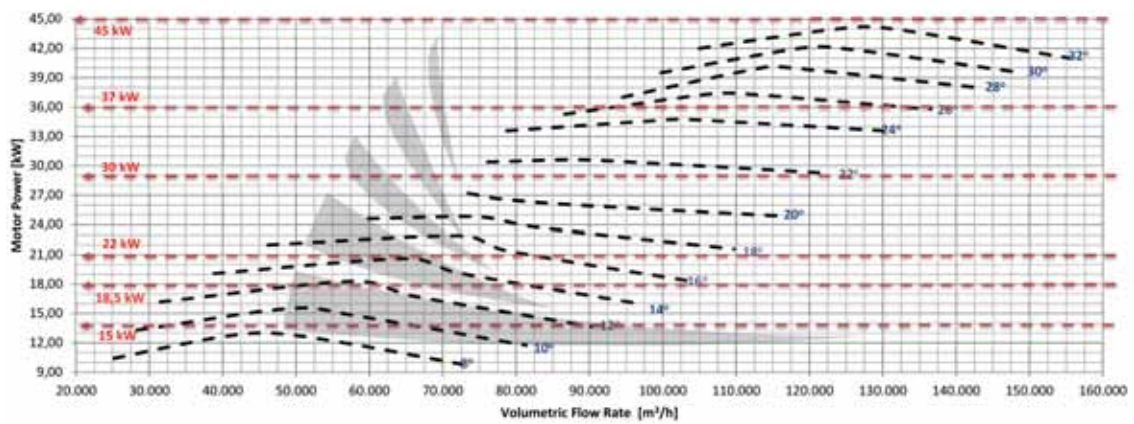
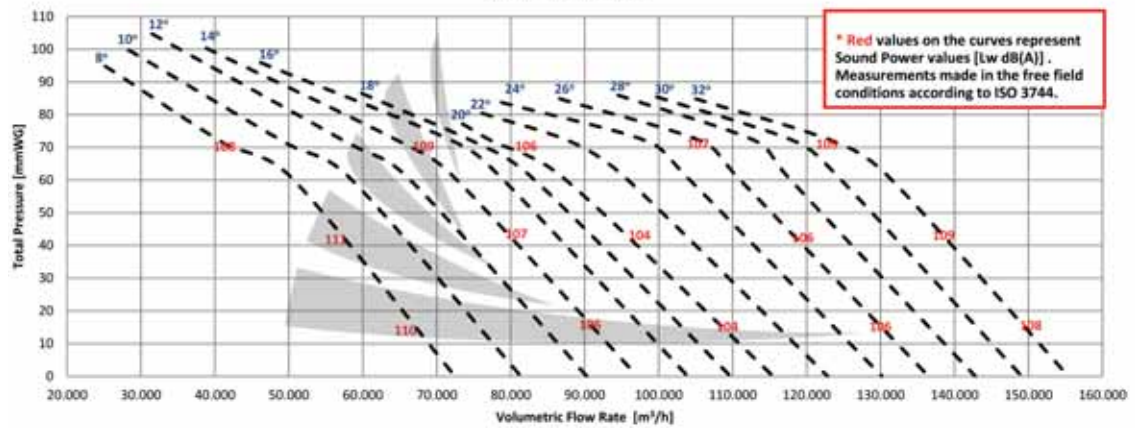

ARMO-A1250/9/4A

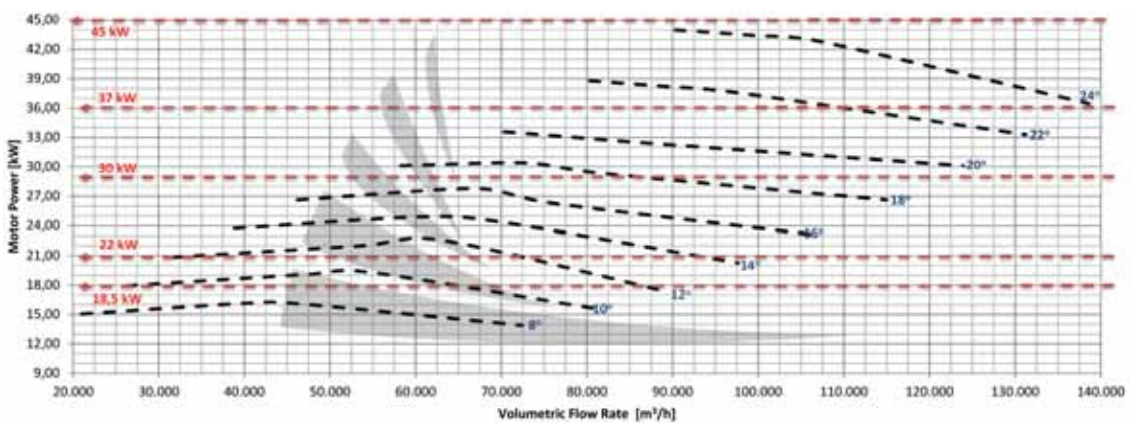
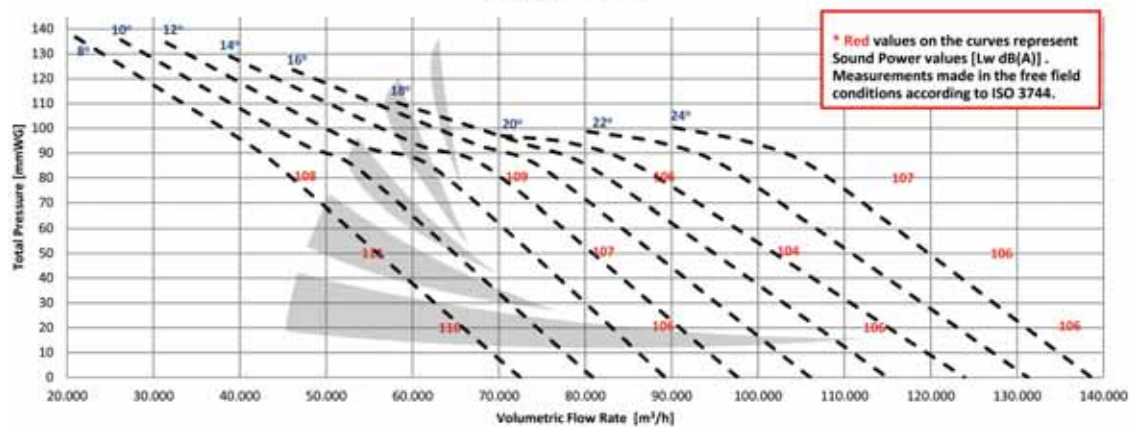



### ARMO-A500/6/6A

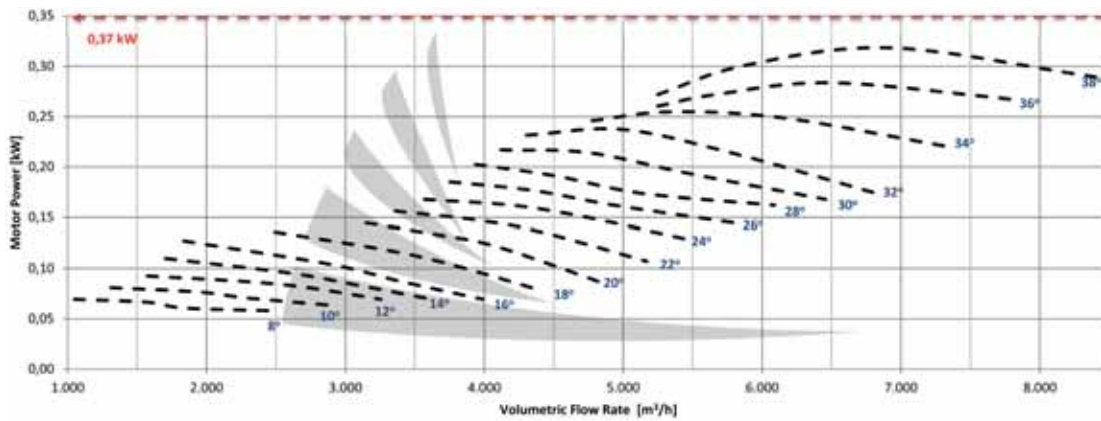
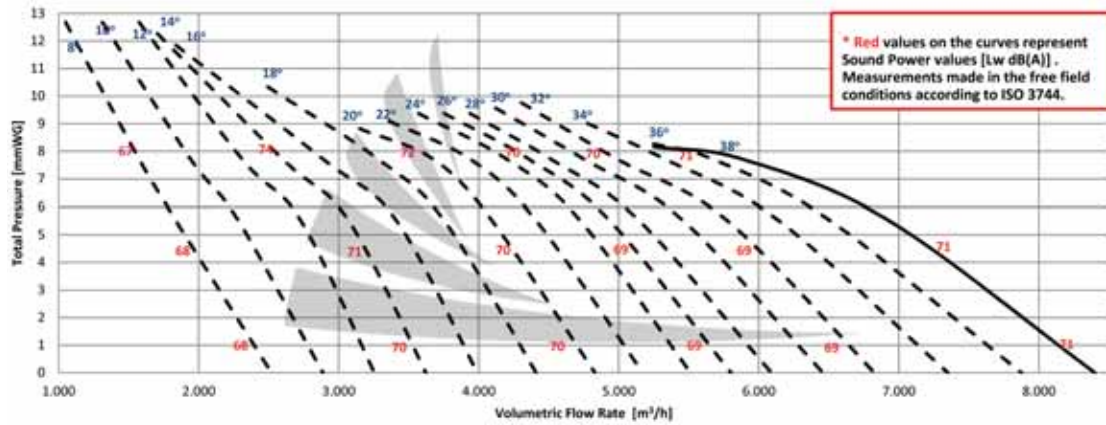

### ARMO-A560/6/6A

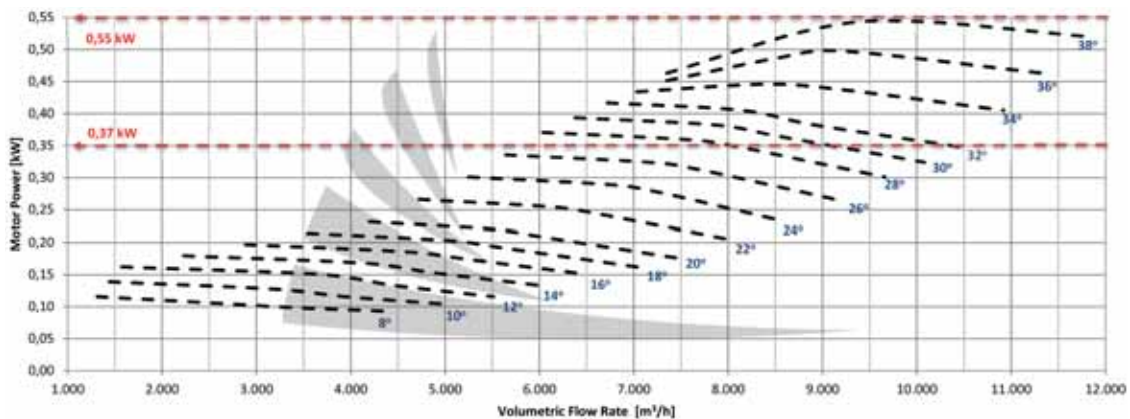
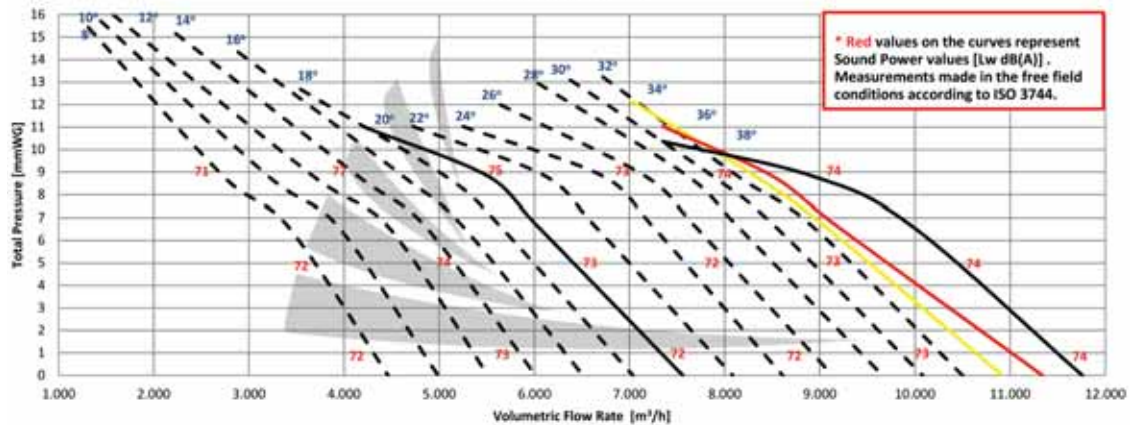

DUCT FANS

ROOF FANS

AXIAL FANS

RADIAL FANS

PLASTIC FANS

VENTILATORS

SMOKE EXHAUST SYSTEMS

ACCESSORIES



# SMOKE AND HEAT EXHAUST VENTILATION SYSTEMS

ARMO-A630/6/6A

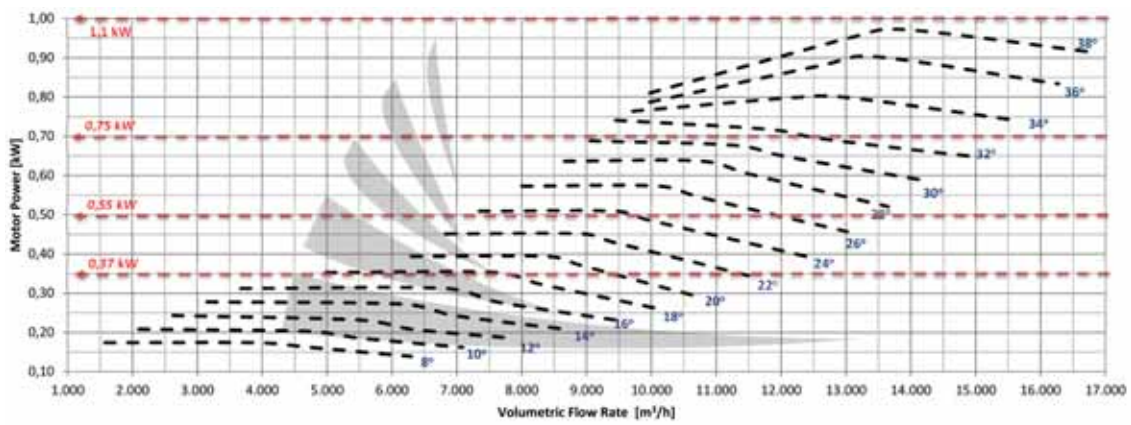
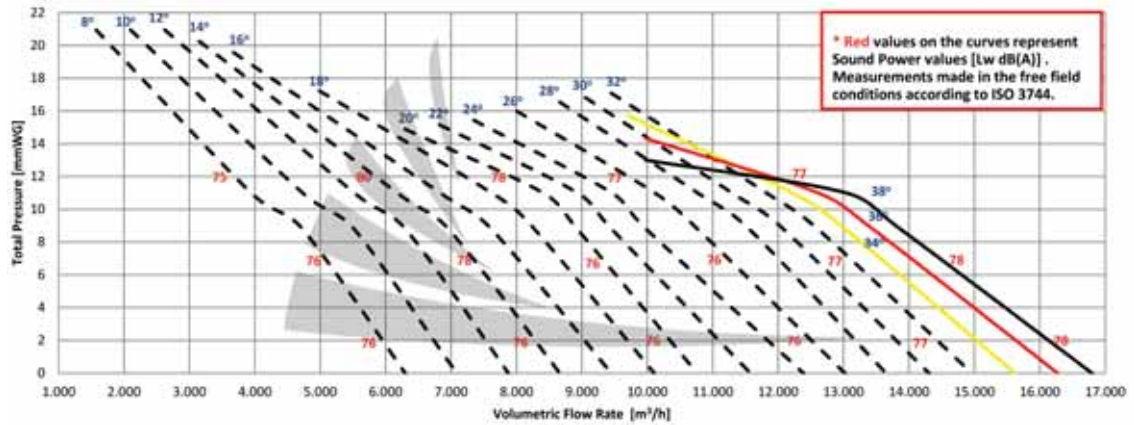

ARMO-A710/3/6A

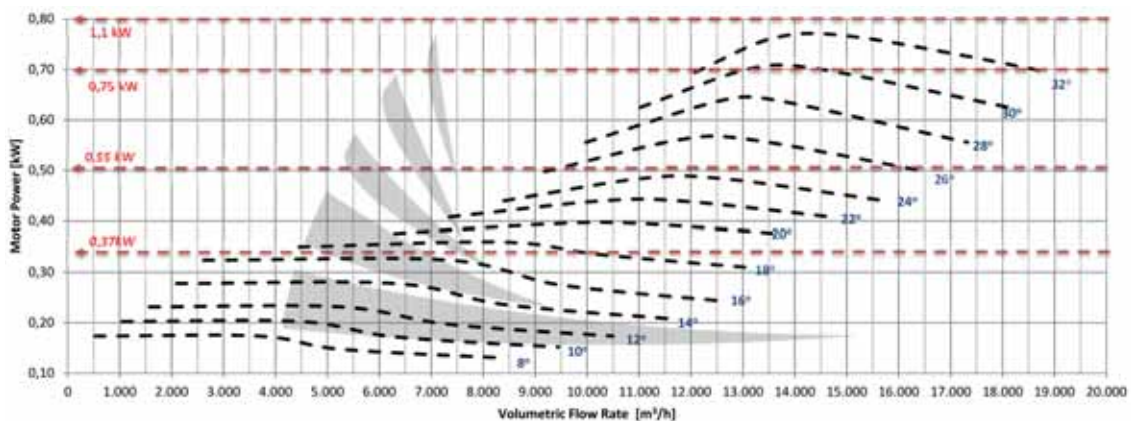
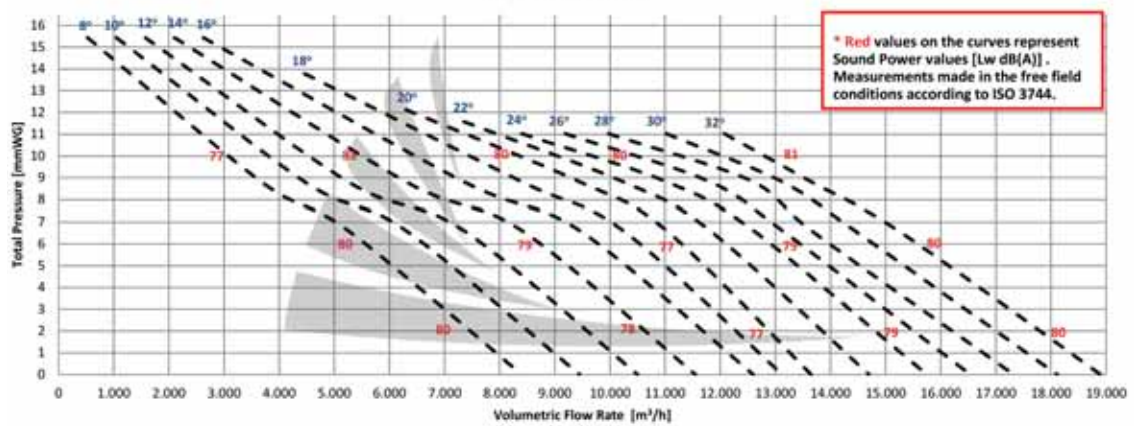

### ARMO-A710/6/6A

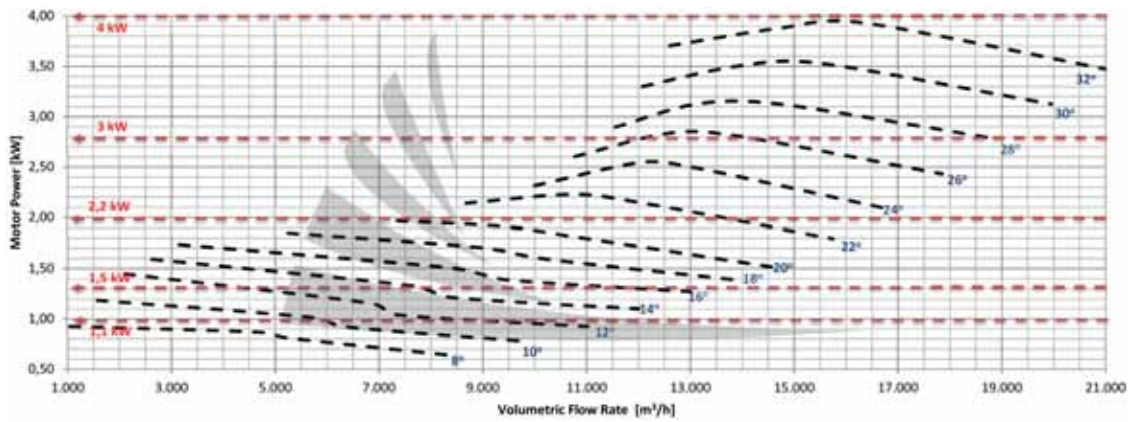
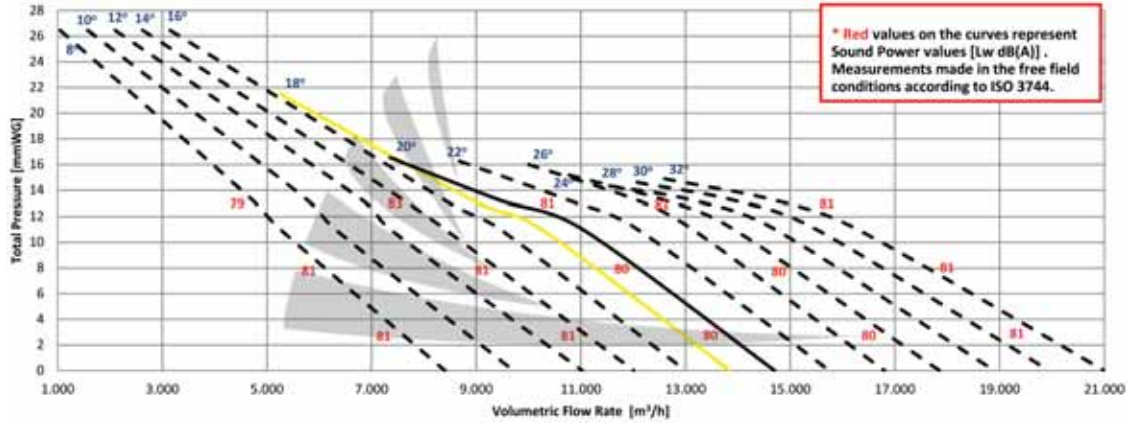

### ARMO-A800/6/6A

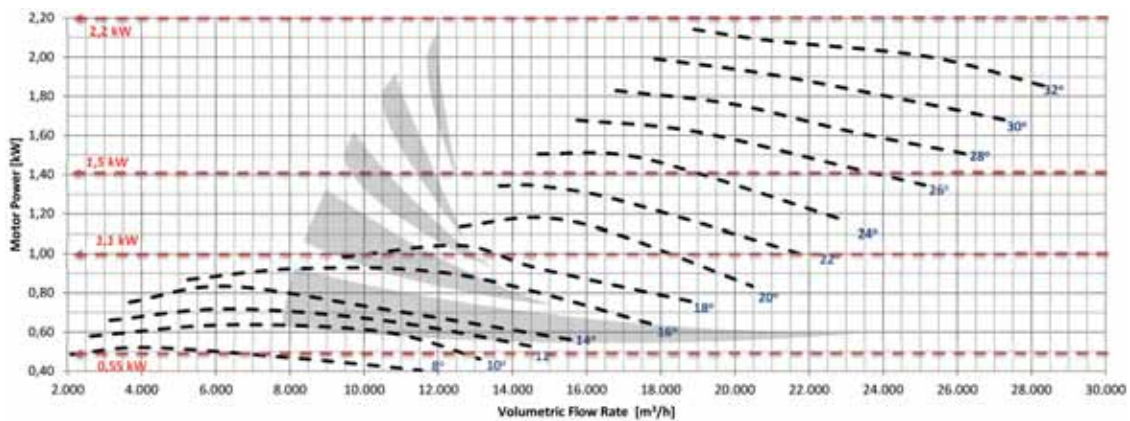
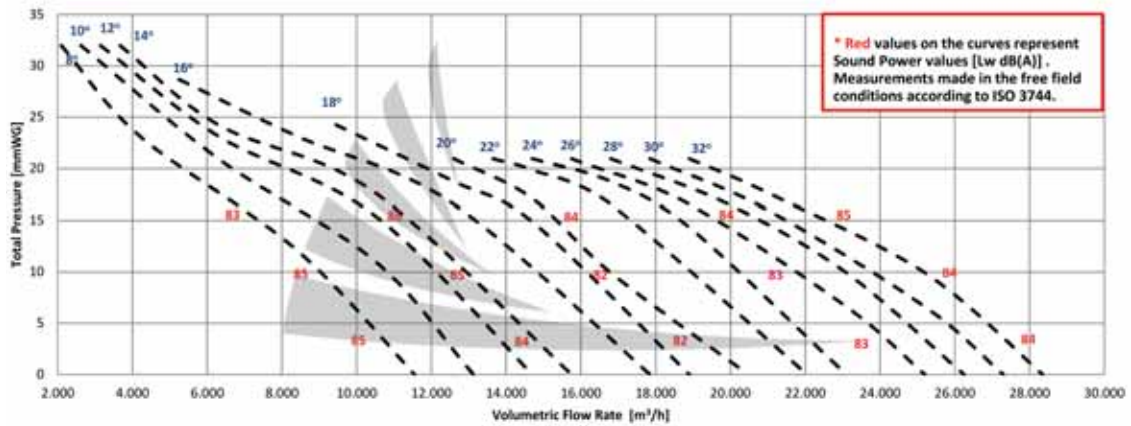

DUCT FANS

ROOF FANS

AXIAL FANS

RADIAL FANS

PLASTIC FANS

VENTILATORS

SMOKE EXHAUST SYSTEMS

ACCESSORIES



# SMOKE AND HEAT EXHAUST VENTILATION SYSTEMS

ARMO-A800/9/6A

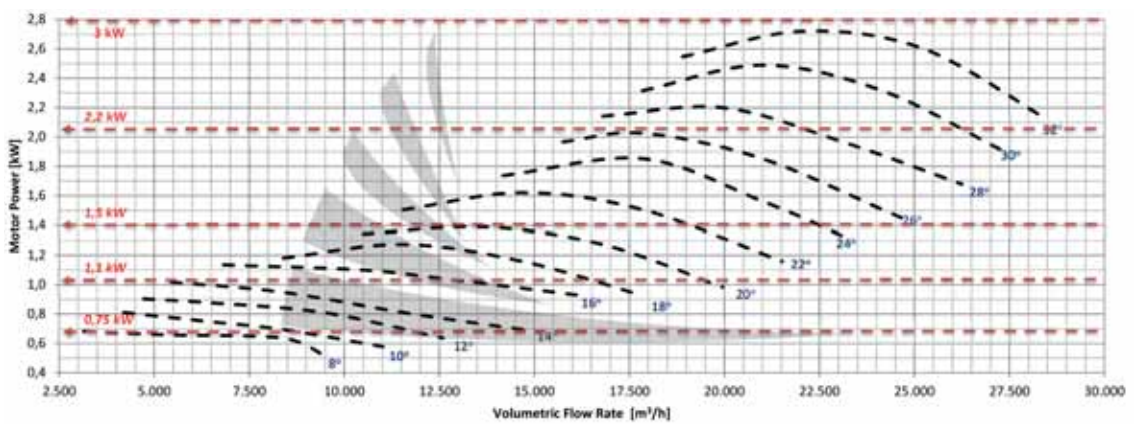
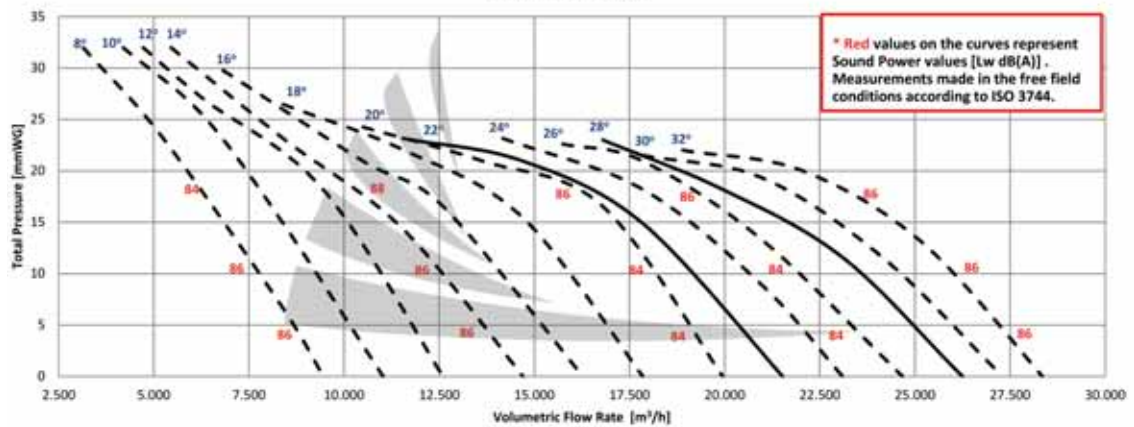

ARMO-A900/6/6A

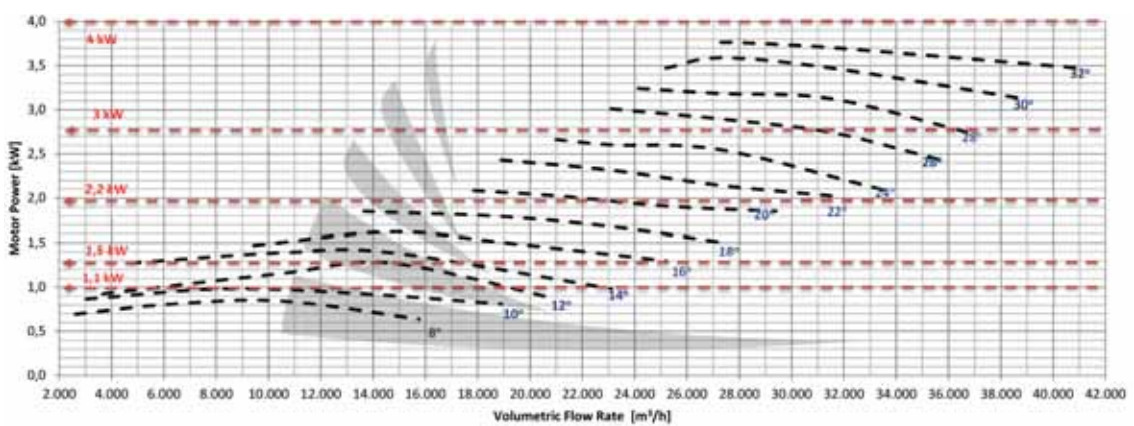
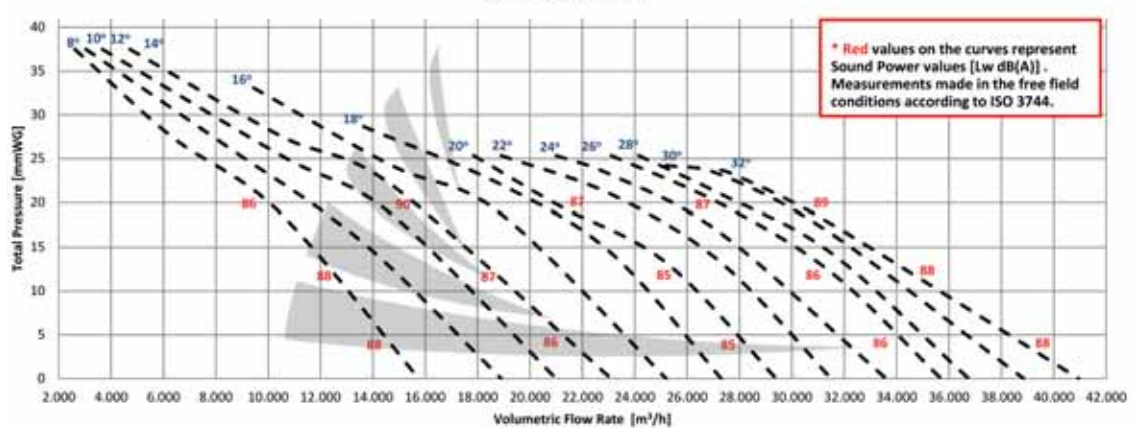



### ARMO-A900/9/6A

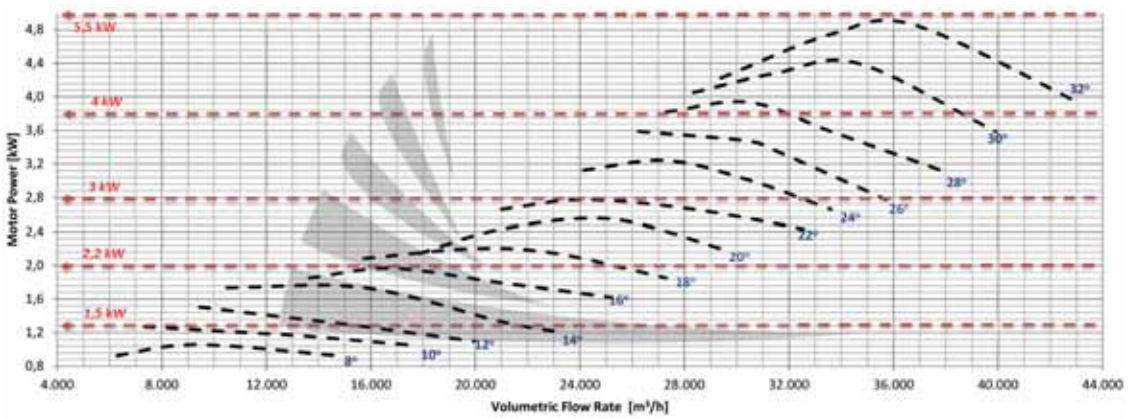
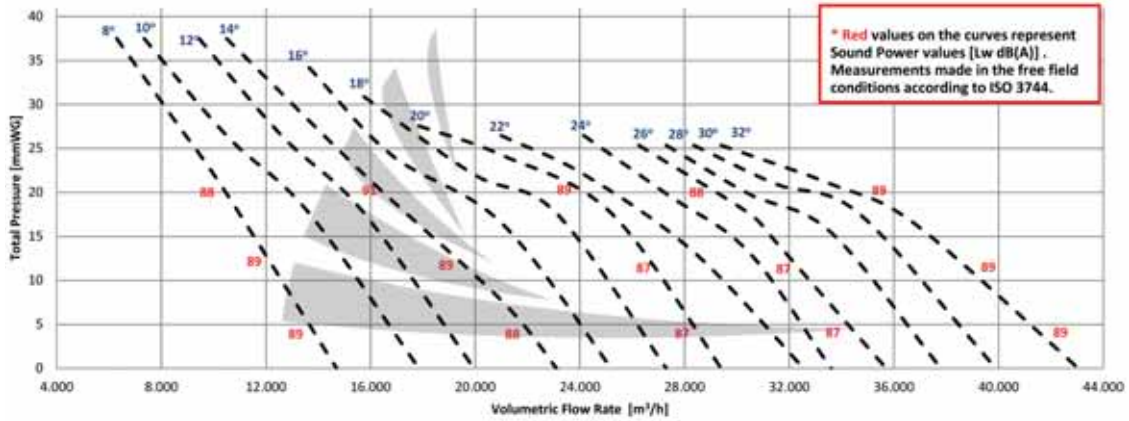

### ARMO-A1000/6/6A

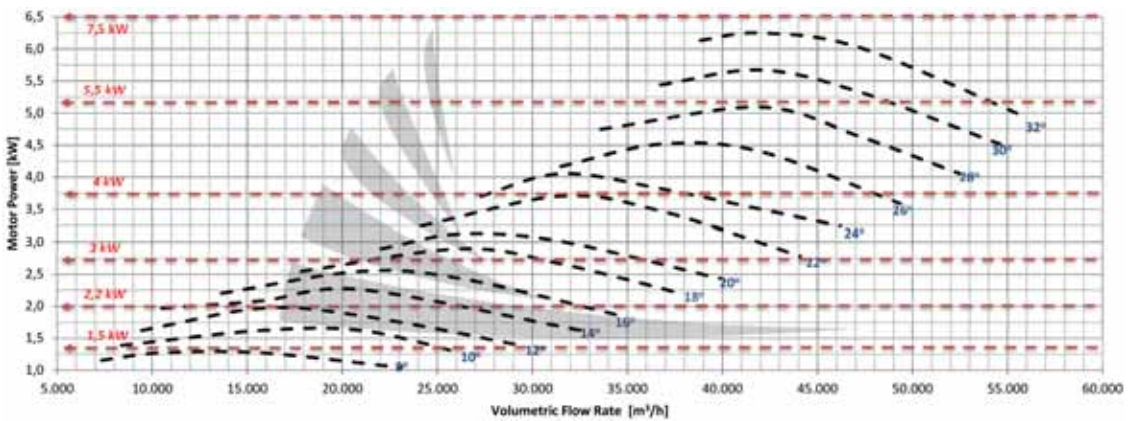
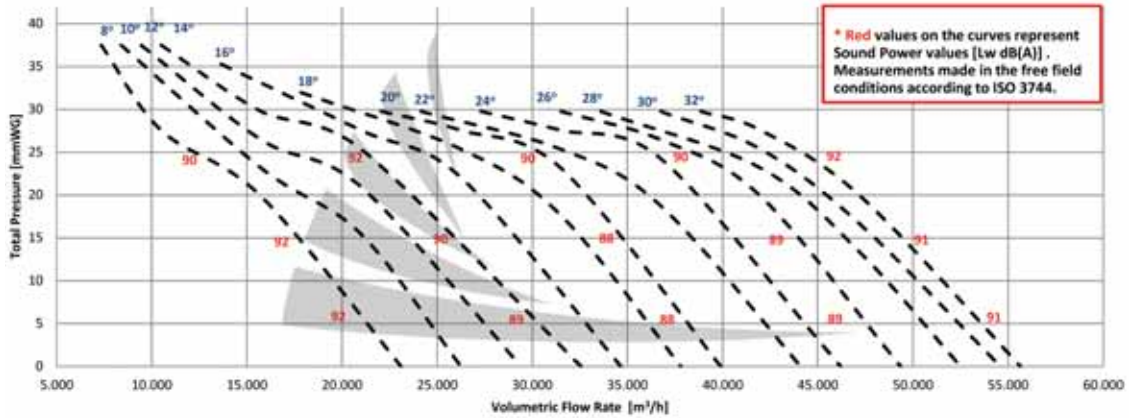

DUCT FANS

ROOF FANS

AXIAL FANS

RADIAL FANS

PLASTIC FANS

VENTILATORS

SMOKE EXHAUST SYSTEMS

ACCESSORIES

# SMOKE AND HEAT EXHAUST VENTILATION SYSTEMS

ARMO-A1000/9/6A

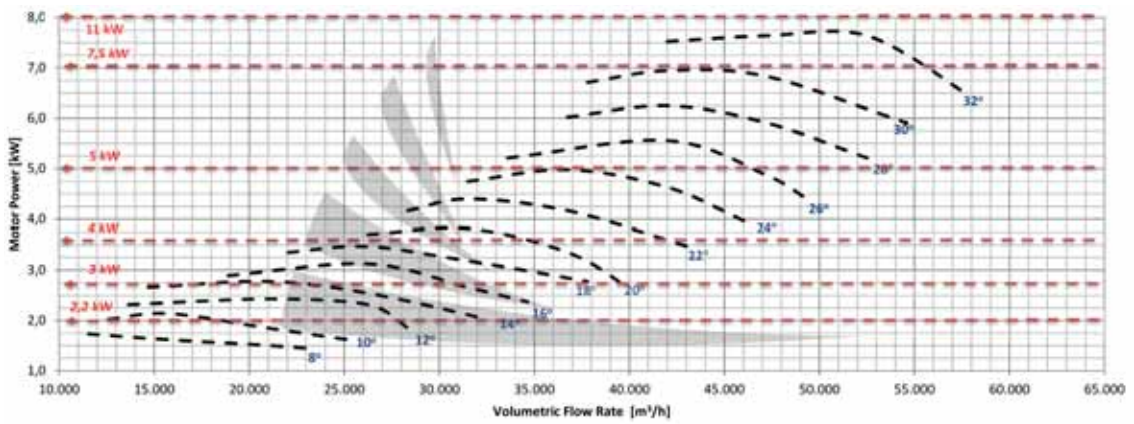
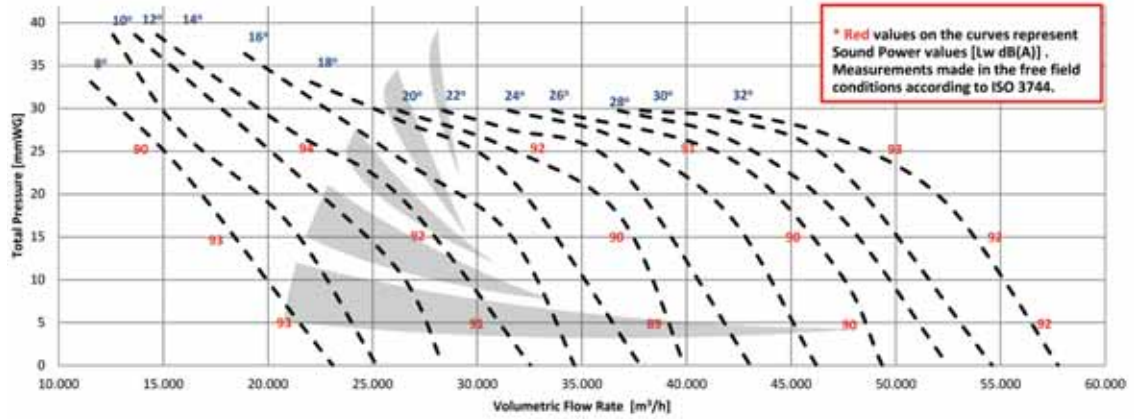

ARMO-A1250/6/6A

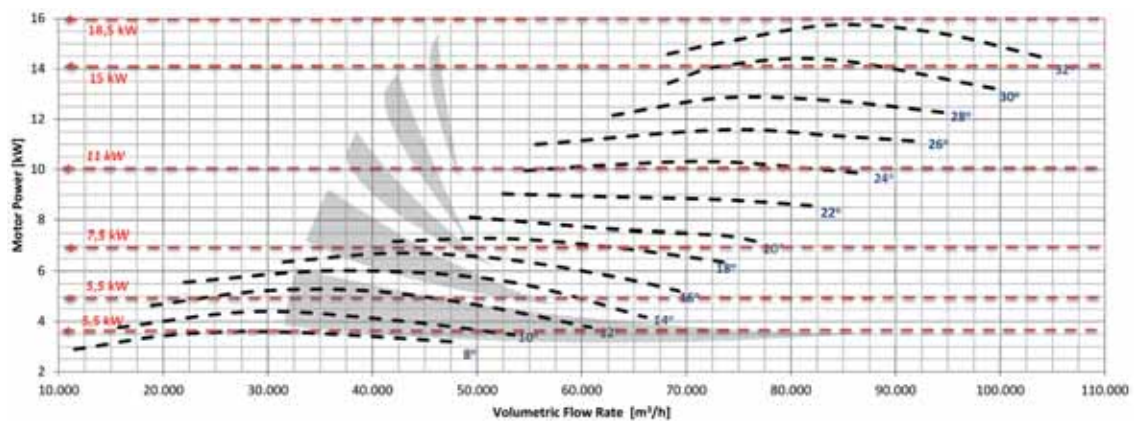
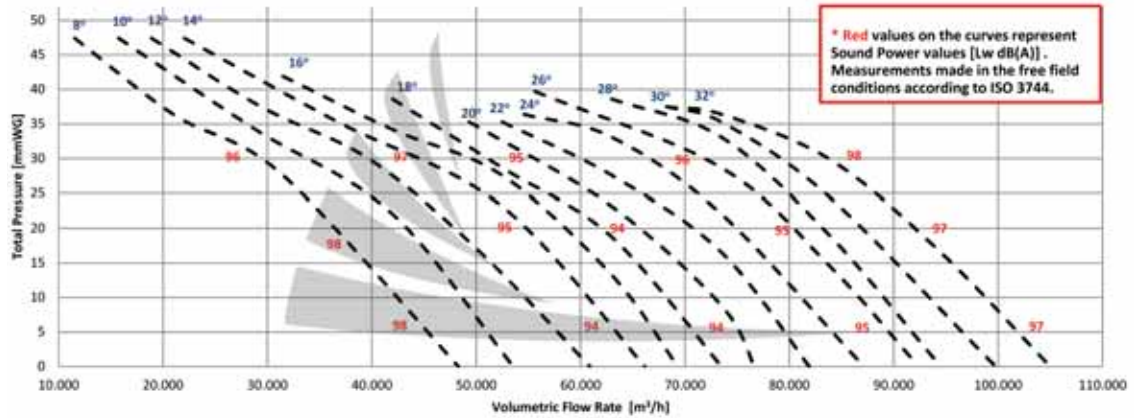



### ARMO-A1250/9/6A

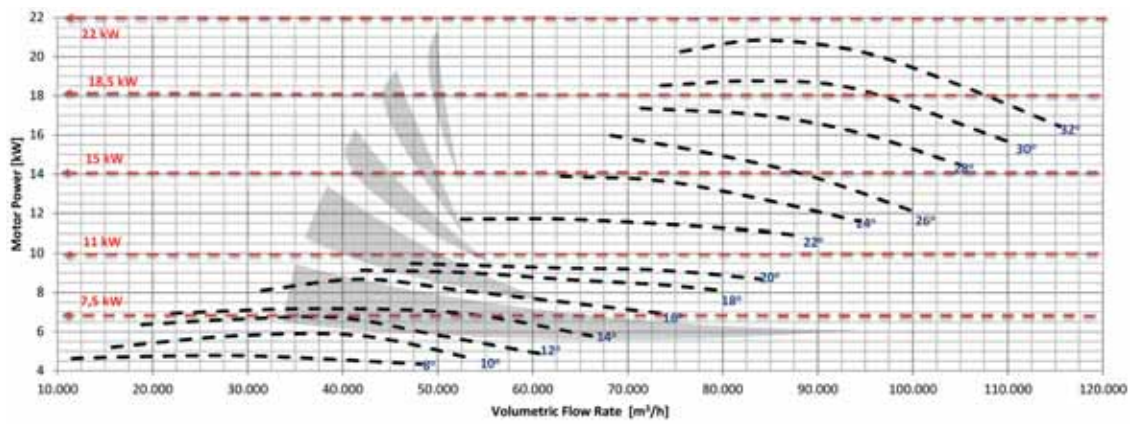
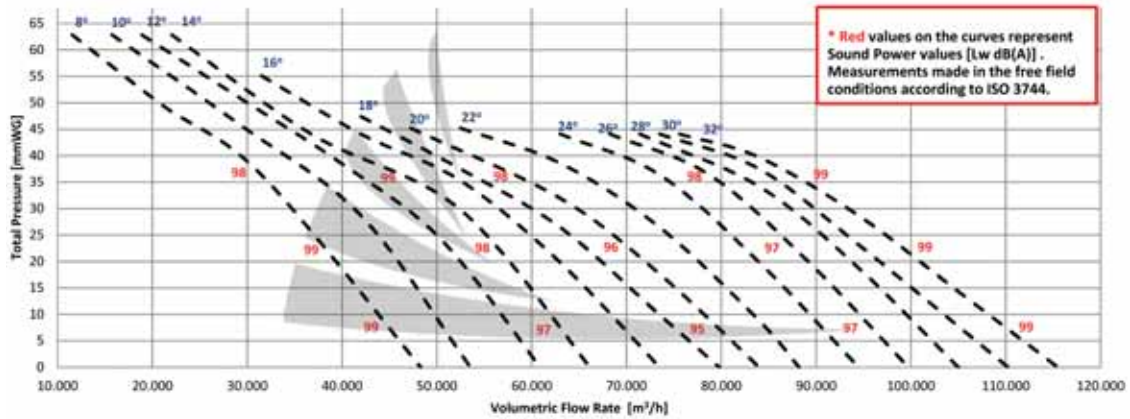

### JET FAN CODES

### CYLINDRICAL CASED AXIAL FAN CODES

