



Range of centrifugal roof mounted fans in horizontal discharge format, designed for smoke extraction in fire conditions and certified F400-120 (CE marked) (1). All models are suitable for air stream temperature up to 120°C. Bases are manufactured from galvanised sheet steel and cowls are manufactured from spun aluminium. All models incorporate bird-proof guard. Available, depending upon the model, with single or three phase motors in 4, 6, 8, 4/8 or 6/12 poles.  
 (1) Except 140, 180 and 200 models.

**Motors**

All motors are IP55, Class F and equipped with ball bearings greased for life. Electrical supply:  
 Single phase 230V-50Hz.  
 Three phase 400V-50Hz.  
 [See characteristics chart].  
 Speed controllable by voltage, up to 400 model. Three phase motors are controllable by frequency inverter. When is using a speed controller, the electrical installation must be equipped with a security system which allows the maximum speed of the fans in cas of fire.

**Additional information**

140, 180, 200 and 225 models are specially recommended for extracting smoke from the fireplaces.



**Easy to install**  
 Supports easing the installation on the roof.

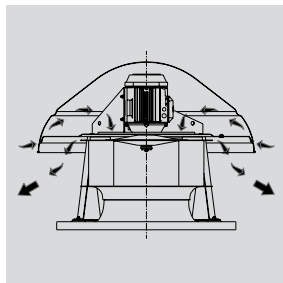

**Self cooling system**  
 Special design in order to cool the motor and to extend the life of the assembly.

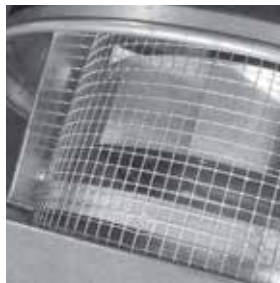

**Bird-proof guard.**

Only F400-120 at maximum fan speed.

**Specific applications**



Approved to EN12101-3 standard Certificate n° 0370-CPD-0347



Continuous operation



Car Parks



Industrial and commercial kitchens

**Additional applications for 140,180,200 and 225 models**



Continuous



Smoke extract



**Backward curved centrifugal impellers**

To prevent accumulation of dirt. Models up to 400 are manufactured from galvanised steel sheet. Models from 450 to 630 are manufactured in sheet steel protected against corrosion by cataforesis primer and black polyester paint finish.



Models configuration 140 to 400



Range of centrifugal roof mounted fans in vertical discharge format, designed for smoke extraction in fire conditions and certified F400-120 (CE marked) (1). All models are suitable for air stream temperature up to 120°C. Bases are manufactured from galvanised sheet steel and cowls are manufactured from spun aluminium. All models incorporate bird-proof guard. Available, depending upon the model, with single or three phase motors in 4, 6, 8, 4/8 or 6/12 poles.

(1) Except 140, 180 and 200 models.

**Motors**

All motors are IP55, Class F and equipped with ball bearings greased for life.

Electrical supply:

Single phase 230V-50Hz.

Three phase 400V-50Hz.

(See characteristics chart).

Speed controllable by voltage, up to 400 model. Three phase motors are controllable by frequency inverter.

When is using a speed controller, the electrical installation must be equipped with a security system which allows the maximum speed of the fans in cas of fire.



Models configuration 450 to 710

**Additional information**

140, 180, 200 and 225 models are specially recommended for extracting smoke from the fireplaces.

Only F400-120 at maximum fan speed.

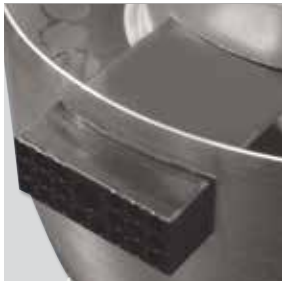

**Cooling duct**

Enables the motor cooling when the fan is extracting air at an extremely high temperature.



**Easy to install**

Supports easing the installation on the roof.

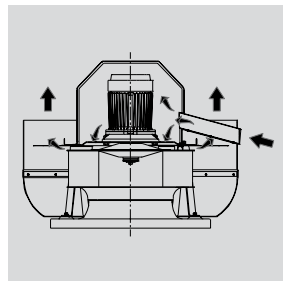

**Self cooling system**

Special design in order to cool the motor and to extend the life of the assembly.

**Specific applications**



Approved to EN12101-3 standard Certificate n° 0370-CPD-0347



Continuous operation



Car Parks



Industrial and commercial kitchens



**Backward curved centrifugal impellers**

To prevent accumulation of dirt. Models up to 400 are manufactured from galvanised steel sheet. Models from 450 to 630 are manufactured in sheet steel protected against corrosion by cataforesis primer and black polyester paint finish.



**Bird-proof guard.**

**Additional applications for 140,180,200 and 225 models**



Continuous



Smoke extract

**TECHNICAL CHARACTERISTICS FOR MODELS WITH HORIZONTAL DISCHARGE CTHB/ CTHT**

Before installation check that the product electrical characteristics listed on the data plate label (voltage, power, frequency, etc.) match those of the intended electrical supply.

Model		Speed (rpm)	Maximum absorbed power (W)	Maximum absorbed current (A)		Maximum airflow (m <sup>3</sup> /h)	Sound pressure level* at 2/3 Qmax (dB(A))		Weight (kg)	Speed controllable (**)	Switch for 2-speed motors
				at 230 V	at 400 V		Inlet	Outlet			
4 poles single phase	CTHB/4-140	1370	60	0,32	-	800	46	52	7,5	REB-1N	-
	CTHB/4-180	1330	70	0,33	-	990	46	52	8	REB-1N	-
	CTHB/4-200	1320	120	0,60	-	1450	49	55	14,2	REB-1N	-
	CTHB/4-225	1350	170	0,90	-	2100	53	59	17	REB-2,5N	-
	CTHB/4-250	1320	280	1,40	-	3100	57	62	28	REB-2,5N	-
	CTHB/4-315	1375	590	2,70	-	4900	60	66	32	REB-5	-
	CTHB/4-400	1380	1100	5,30	-	7000	67	73	42,5	REB-10	-
6 poles single phase	CTHB/6-200	940	80	0,40	-	970	38	45	14,2	REB-1N	-
	CTHB/6-225	890	90	0,40	-	1400	42	48	17	REB-1N	-
	CTHB/6-250	940	100	0,57	-	2000	45	52	28	REB-1N	-
	CTHB/6-315	840	170	0,81	-	3200	49	55	32	REB-1N	-
	CTHB/6-400	950	350	1,60	-	4500	56	62	42,5	REB-2,5N	-
4 poles three phase	CTHT/4-140	1375	60	-	0,17	800	46	52	7,5	RMT-1,5	-
	CTHT/4-180	1350	70	-	0,17	990	46	52	8	RMT-1,5	-
	CTHT/4-200	1340	130	-	0,35	1450	49	55	14,2	RMT-1,5	-
	CTHT/4-225	1360	170	-	0,50	2100	53	59	17	RMT-1,5	-
	CTHT/4-250	1400	300	-	0,80	3100	57	62	28	RMT-1,5	-
	CTHT/4-315	1410	620	-	1,50	4900	60	66	32	RMT-2,5	-
	CTHT/4-400	1350	920	-	1,80	7000	67	73	42,5	RMT-2,5	-
	CTHT/4-450	1440	2300	-	4,60	10200	71	76	67	VFKB-48	-
6 poles three phase	CTHT/6-200	950	80	-	0,24	970	38	45	14,2	RMT-1,5	-
	CTHT/6-225	900	90	-	0,23	1400	42	48	17	RMT-1,5	-
	CTHT/6-250	950	100	-	0,41	2000	45	52	28	RMT-1,5	-
	CTHT/6-315	900	180	-	0,50	3200	49	55	32	RMT-1,5	-
	CTHT/6-400	925	350	-	1,00	4500	56	62	42,5	RMT-1,5	-
	CTHT/6-450	940	850	-	3,50	6900	59	66	67	VFKB-45	-
	CTHT/6-500	965	1400	-	4,30	10500	63	69	104	VFKB-45	-
	CTHT/6-560	950	2400	-	5,30	16000	66	73	118	VFKB-48	-
	CTHT/6-630	950	3700	-	8,30	21000	70	76	156	VFTM-TRI 4	-
	CTHT/6-710	980	6800	-	13,80	28900	77	83	217	VFTM-TRI 7,5	-
8 poles three phase	CTHT/8-450	700	700	-	2,10	5000	55	61	67	VFKB-45	-
	CTHT/8-500	725	770	-	2,40	7500	55	62	104	VFKB-45	-
	CTHT/8-560	730	1100	-	3,60	11500	58	65	118	VFKB-45	-
	CTHT/8-630	735	1650	-	4,90	15000	62	69	156	VFKB-48	-
	CTHT/8-710	730	2900	-	7,20	21700	70	76	226	VFKB-48	-
	CTHT/4/8-225	1300/700	180/70	-	0,3/0,2	2100/1050	53/38	59/44	17	-	-
	CTHT/4/8-315	1400/700	370/230	-	1,1/0,9	4900/2400	60/45	66/51	33	-	DEMA 1/1,3 DH
	CTHT/4/8-400	1400/700	1000/260	-	1,8/1,0	7000/3500	67/52	73/58	44	-	DEMA 1/2,3 DH
2 speeds three phase	CTHT/4/8-450	1400/700	2400/600	-	6,1/2,5	10200/5100	71/55	76/61	69	-	DEMA 3,1/7,6 DH
	CTHT/6/12-450	960/490	500/190	-	2/1	6900/3400	59/44	66/51	72	-	DEMA 1/2,3 DH
	CTHT/6/12-500	980/490	1520/430	-	4,5/2,2	10500/5300	63/48	69/54	109	-	DEMA 2,3/5,7 DH
	CTHT/6/12-560	950/480	2400/640	-	5,6/2,2	16000/7000	66/51	73/58	124	-	DEMA 2,3/5,7 DH
	CTHT/6/12-630	960/480	4100/730	-	8,1/2,6	21000/10500	70/55	76/61	161	-	DEMA 3,1/10 DH
CTHT/6/12-710	950/450	6700/850	-	14,1/5,4	28900/15000	77/62	83/68	226	-	DEMA 5,7/15,5 DH	

\* The ratings of sound levels are pressure values measured in dB(A) at 1,5 m at 2/3 Qmax.

\*\* Three phase speed controllers (RMT) or inverter controller (VFKB/VFTM): Three phase 400V.

**TECHNICAL CHARACTERISTICS FOR MODELS WITH VERTICAL DISCHARGE CTVB/CTVT**

Before installation check that the product electrical characteristics listed on the data plate label (voltage, power, frequency, etc.) match those of the intended electrical supply.

Model	Speed (rpm)	Maximum absorbed power (W)	Maximum absorbed current (A)		Maximum airflow (m³/h)	Sound pressure level* at 2/3 Qmax (dB(A))		Weight (kg)	Speed controllable (**)	Switch for 2-speed motors	
			at 230 V	at 400 V		Inlet	Outlet				
4 poles single phase	CTVB/4-140	1375	60	0,3	-	725	46	49	10	REB-1N	-
	CTVB/4-180	1330	60	0,3	-	830	46	49	10,5	REB-1N	-
	CTVB/4-200	1330	100	0,60	-	1320	49	53	17	REB-1N	-
	CTVB/4-225	1350	130	0,71	-	1900	53	56	19,8	REB-1N	-
	CTVB/4-250	1325	325	1,6	-	2800	56	60	35	REB-2,5N	-
	CTVB/4-315	1390	570	2,70	-	4200	60	64	39	REB-5	-
	CTVB/4-400	1390	1100	5,30	-	6250	67	70	50	REB-10	-
6 poles single phase	CTVB/6-200	940	80	0,40	-	900	38	42	17	REB-1N	-
	CTVB/6-225	890	90	0,40	-	1300	41	45	19,8	REB-1N	-
	CTVB/6-250	940	100	0,57	-	1850	45	49	35	REB-1N	-
	CTVB/6-315	870	160	0,80	-	2800	48	53	39	REB-1N	-
	CTVB/6-400	960	340	1,60	-	4300	55	59	50	REB-2,5N	-
4 poles three phase	CTVT/4-140	1400	60	-	0,18	725	46	49	10	RMT-1,5	-
	CTVT/4-180	1350	60	-	0,18	830	46	49	10,5	RMT-1,5	-
	CTVT/4-200	1340	130	-	0,44	1200	49	53	17	RMT-1,5	-
	CTVT/4-225	1360	180	-	0,47	1900	53	56	19,8	RMT-1,5	-
	CTVT/4-250	1400	300	-	0,8	2800	56	60	35	RMT-1,5	-
	CTVT/4-315	1410	400	-	1,4	4200	60	64	39	RMT-2,5	-
	CTVT/4-400	1330	1000	-	1,80	6250	67	70	50	RMT-2,5	-
	CTVT/4-450	1440	2100	-	4,3	8850	70	74	75	VFKB-45	-
6 poles three phase	CTVT/6-200	950	80	-	0,24	900	38	42	17	RMT-1,5	-
	CTVT/6-225	900	90	-	0,23	1300	41	45	19,8	RMT-1,5	-
	CTVT/6-250	950	100	-	0,41	1850	45	49	35	RMT-1,5	-
	CTVT/6-315	910	160	-	0,44	2800	48	53	39	RMT-1,5	-
	CTVT/6-400	930	350	-	1,00	4300	55	59	50	RMT-1,5	-
	CTVT/6-450	950	800	-	3,5	5900	59	63	75	VFKB-45	-
	CTVT/6-500	975	1500	-	3,7	9500	62	66	115	VFKB-45	-
	CTVT/6-560	950	2400	-	5,50	13000	66	70	129	VFKB-48	-
	CTVT/6-630	950	3900	-	8,3	19500	70	74	168	VFTM-TRI 4	-
	CTVT/6-710	980	7250	-	13,6	25200	77	82	229	VFTM-TRI 7,5	-
8 poles three phase	CTVT/8-450	690	700	-	1,5	4.400	55	59	75	VFKB-45	-
	CTVT/8-500	700	770	-	2,4	7100	54	58	115	VFKB-45	-
	CTVT/8-560	730	1100	-	3,3	10000	58	62	129	VFKB-45	-
	CTVT/8-630	735	1650	-	4,90	14500	61	66	168	VFKB-45	-
	CTVT/8-710	730	3160	-	7,10	19100	71	76	238	VFKB-48	-
	CTVT/4/8-225	1300/700	180/70	-	0,3/0,2	2100/1050	53/38	59/44	17	-	-
	CTVT/4/8-315	1400/700	370/230	-	1,1/0,9	4200/2100	60/45	64/49	40	-	DEMA 1/1,3 DH
	CTVT/4/8-400	1400/700	560/260	-	1,3/1,0	6250/3200	67/52	70/55	52	-	DEMA 1/2,3 DH
CTVT/4/8-450	1400/700	2400/600	-	6,1/2,5	9850/4500	70/55	74/59	77	-	DEMA 3,1/7,6 DH	
2 speeds three phase	CTVT/6/12-450	960/490	500/190	-	2/1	5900/2800	59/44	63/48	80	-	DEMA 1/2,3 DH
	CTVT/6/12-500	980/490	1520/430	-	4,5/2,2	9500/4800	62/47	66/51	134	-	DEMA 2,3/5,7 DH
	CTVT/6/12-560	960/480	2400/640	-	5,6/2,2	13000/6400	66/51	70/55	134	-	DEMA 2,3/5,7 DH
	CTVT/6/12-630	960/480	4100/730	-	8,1/2,6	19500/9500	70/54	74/59	173	-	DEMA 3,1/10 DH
	CTVT/6/12-710	950/450	7300/435	-	14/5,4	25200/12700	77/63	82/67	238	-	DEMA 5,7/15,5 DH

\* The ratings of sound levels are pressure values measured in dB(A) at 1,5 m at 2/3 Qmax.

\*\* Three phase speed controllers (RMT) or inverter controller (VFKB/VFTM): Three phase 400V.

**PERFORMANCE CURVES - HORIZONTAL DISCHARGE MODELS**

- $q_v$ : Airflow in  $m^3/h$  and  $m^3/s$ .
- $p_{sf}$ : Static pressure in mmWG and Pa.
- Dry air at 20°C and 760 mmHg.
- Performance data in accordance with ISO 5801 and AMCA 210-99 Standards.

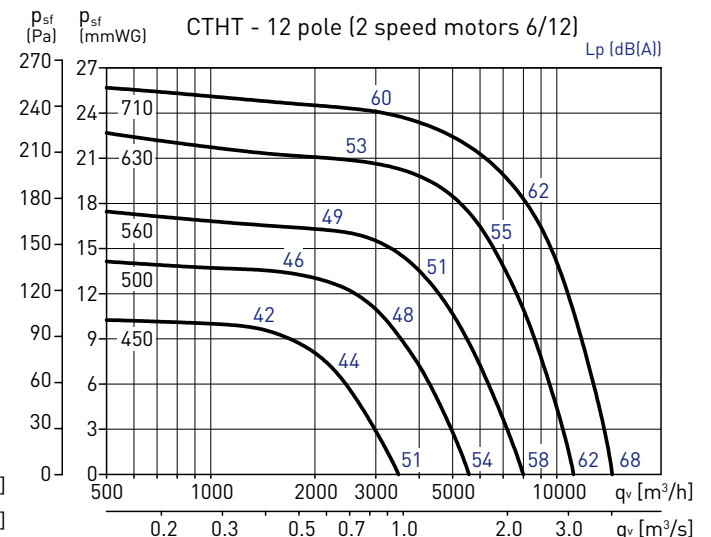
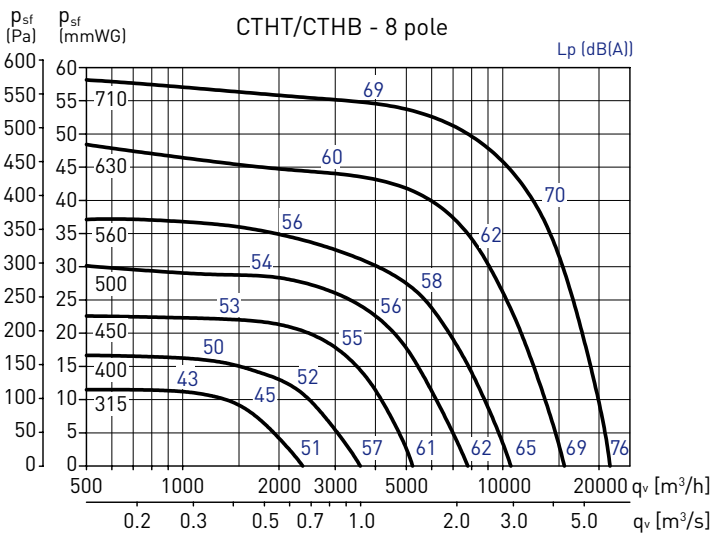
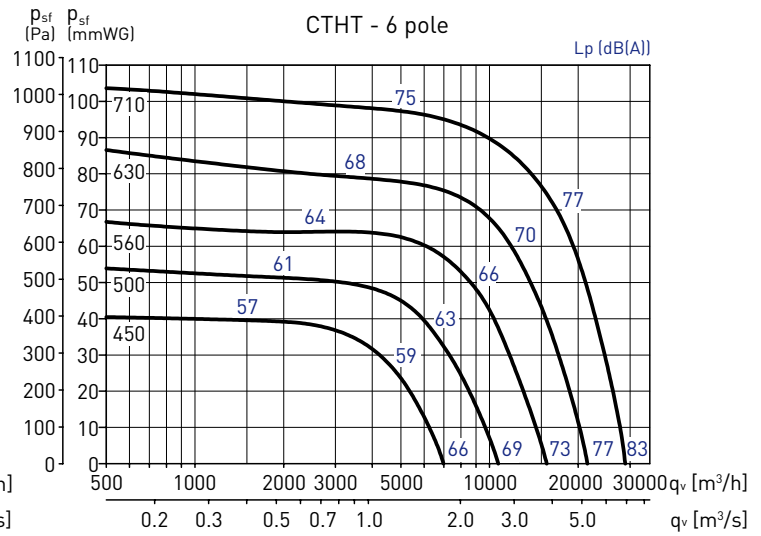
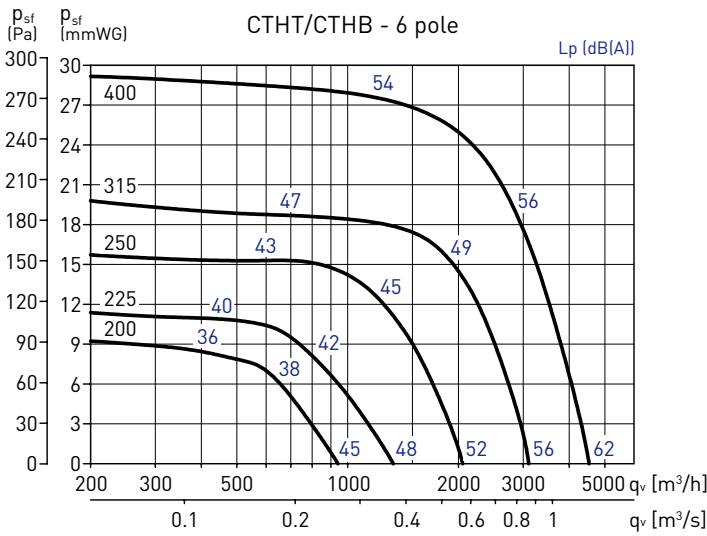
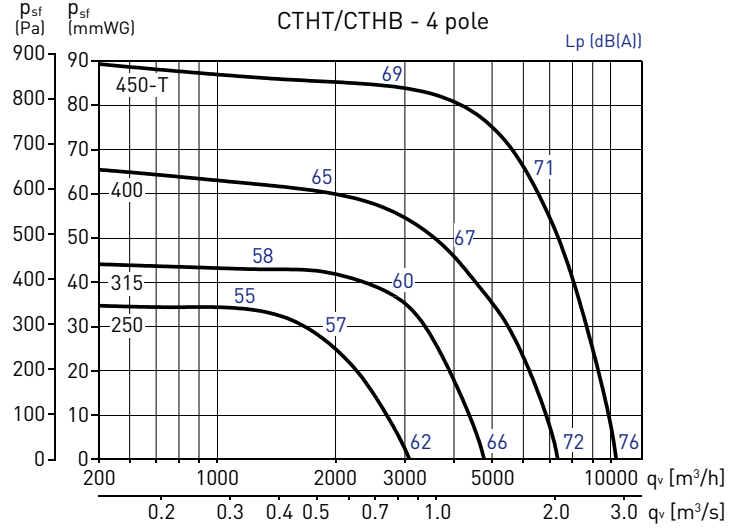
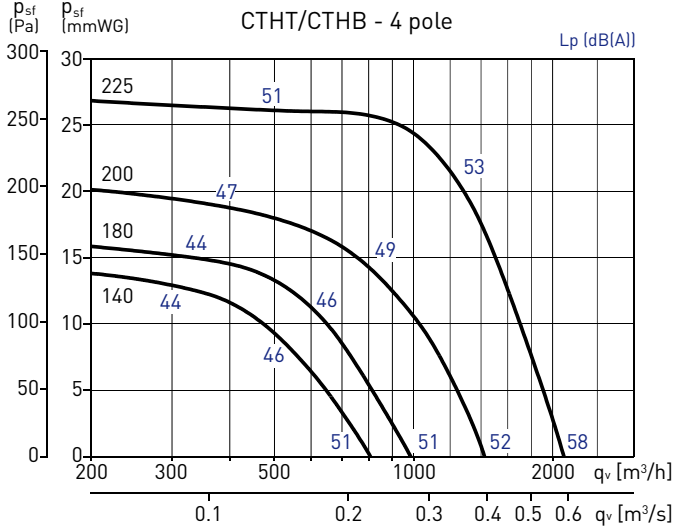

**PERFORMANCE CURVES - VERTICAL DISCHARGE MODELS**

- $q_v$ : Airflow in  $m^3/h$  and  $m^3/s$ .
- $p_{sf}$ : Static pressure in mmWG and Pa.
- Dry air at 20°C and 760 mmHg.
- Performance data in accordance with ISO 5801 and AMCA 210-99 Standards.

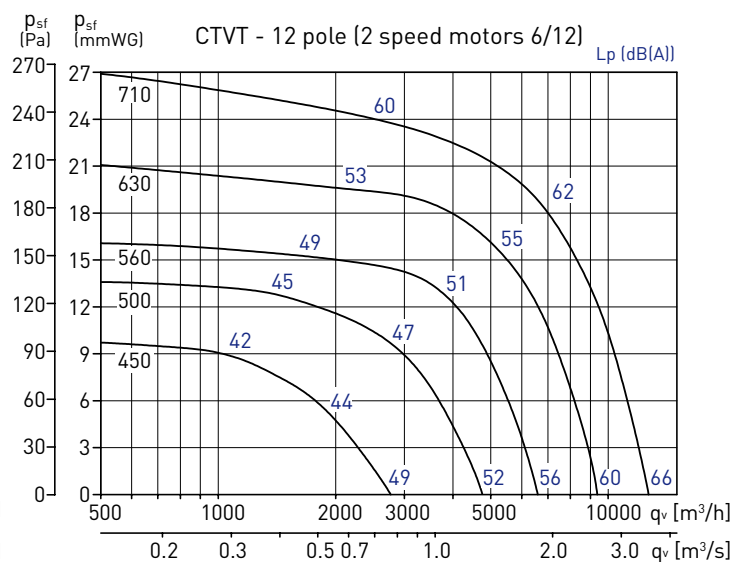
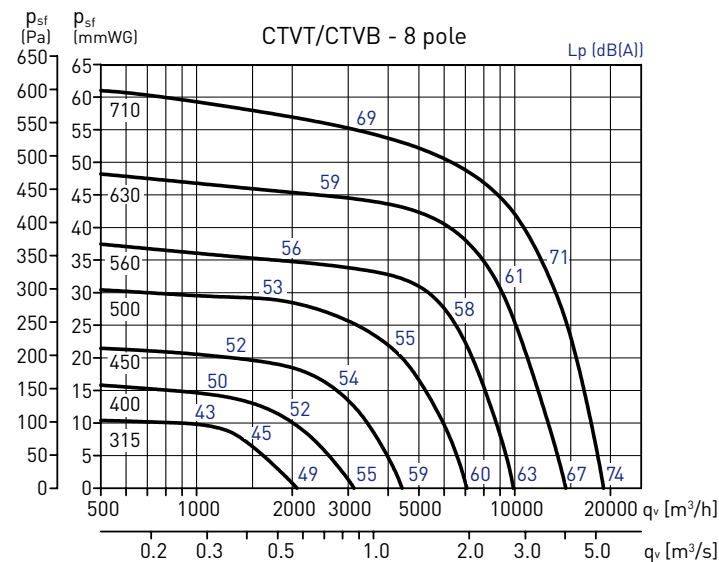
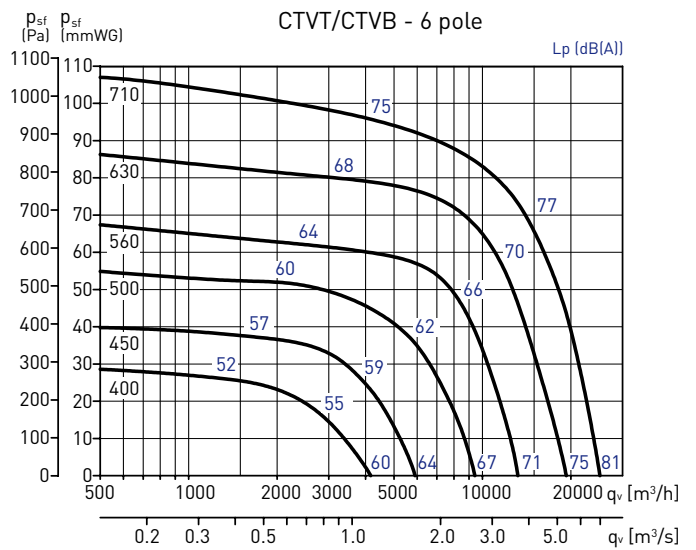
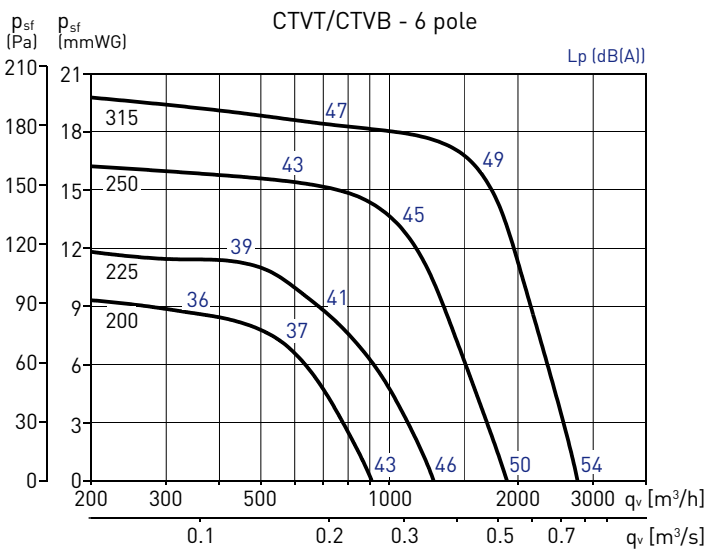
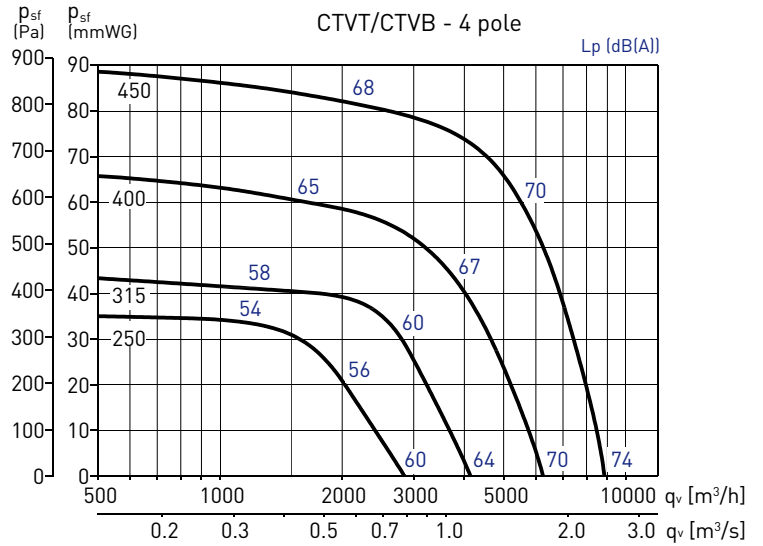
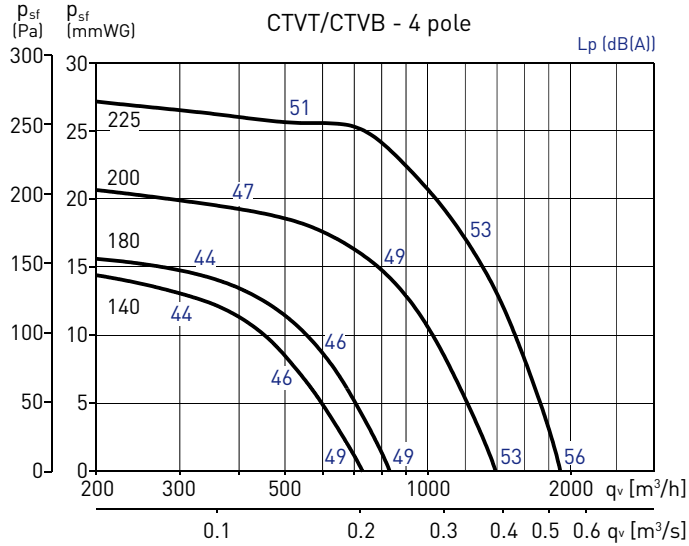

### ACOUSTIC CHARACTERISTICS

#### Sound power spectrum

To obtain the sound power spectrum, subtract the correction value shown in the following chart from the value in the technical characteristics table:

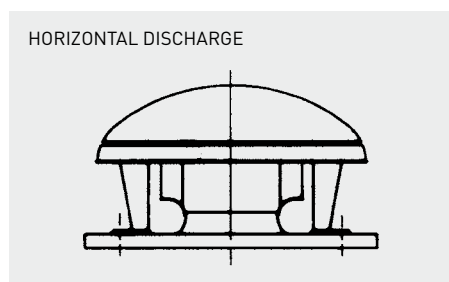

Model		Frequency bands in Hz						
		125	250	500	1000	2000	4000	8000
Outlet	Qmax	2,0	7,5	11,0	11,0	9,0	6,0	0,5
	2/3 Qmax	-0,5	3,5	5,5	5,5	3,5	0,5	-4,5
	1/3 Qmax	-2,5	1,5	3,5	3,5	1,5	-1,5	-6,5
Inlet	Qmax	5,5	9,0	11,5	11,0	10,0	7,5	3,5
	2/3 Qmax	2,5	5,0	6,0	4,5	1,5	-2,5	-8,6
	1/3 Qmax	0,5	3,0	4,0	2,5	-0,5	-4,5	-10,5

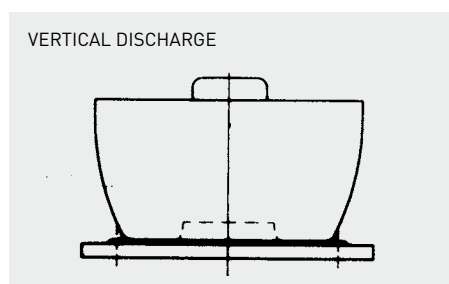

Model		Frequency bands in Hz						
		125	250	500	1000	2000	4000	8000
Outlet	Qmax	3,0	8,0	11,5	11,5	8,0	1,5	-8,0
	2/3 Qmax	0,5	4,5	6,5	5,0	1,5	-3,0	-10,0
	1/3 Qmax	-1,5	2,5	4,5	3,0	-0,5	-5,0	-12,0
Inlet	Qmax	4,5	9,0	10,5	8,5	6,5	5,5	3,0
	2/3 Qmax	3,0	5,0	6,0	4,5	1,0	-3,0	-9,5
	1/3 Qmax	1,0	3,0	4,0	2,5	-1,0	-5,0	-11,5

#### Sound power spectrum

The sound pressure spectrum, at a distance "d", can be obtained by subtracting from each frequency band of the power spectrum, the correction value shown in the following chart:

Distance (d)	1m	1,5m	4m	6m	10m	15m	20m	30m
Correction (dB)	11,00	14,50	23,00	26,00	31,00	34,00	37,00	40,00

### DIMENSIONS (mm)

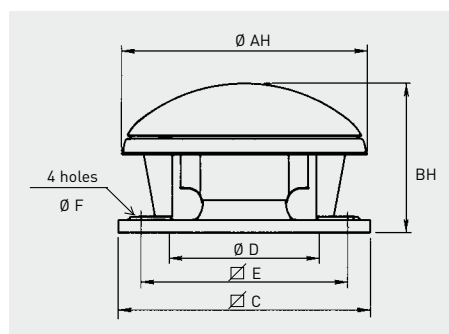

Fan model	Ø AH	Ø AV	BH	BV	□C	Ø D*	□E	Ø F
140	415	421	277	359	300	180	245	10
180	415	421	292	374	300	180	245	10
200	561	556	340	404	435	250	330	12
225	561	570	383	452	435	250	330	12
250	762	750	425	522	560	355	450	12
315	762	750	469	564	560	355	450	12
400	850	850	532	608	630	400	535	12
450	962	950	713	741	710	500	590	14
500	1214	1216	824	832	905	630	750	14
560	1214	1216	874	832	905	630	750	14
630	1336	1327	1029	1053	1100	710	840	14
710	1336	1485	1127	1161	1100	710	840	14

\* Nominal accessories diameter.

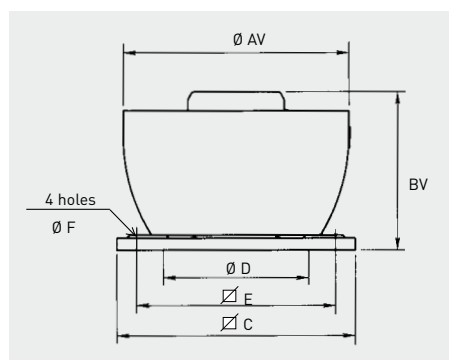

**MOUNTING ACCESSORIES**

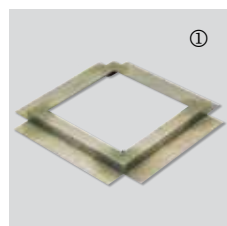

**JMS**  
**Sealing frame**  
- For mounting a roof fan on an up stand or base.  
- Supplied with screws and gasket for a complete weatherproof seal.

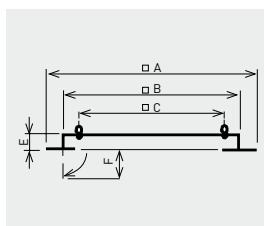

Model	□A	□B	□C	E	F
JMS-300	470	290	245	50	70
JMS-435	600	420	330	50	70
JMS-560	725	545	450	50	70
JMS-630	795	615	535	50	70
JMS-710	875	695	590	50	70
JMS-905	1065	885	750	60	70
JMS-1100	1260	1080	840	60	70

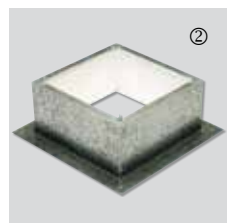

**JBS**  
**Flat roof up stand**  
For mounting a fan on a flat roof without up stands.  
- For use on horizontal roofs.  
- Internal insulation to prevent condensation.  
- Supplied with screws and gasket for a complete weather seal.

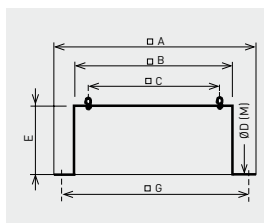

Model	□A	□B	□C	Ø D (M)	E	□G
JBS-300	470	289	245	10,5 (M8)	300	380
JBS-435	600	419	330	11 (M10)	300	510
JBS-560	725	544	450	11 (M10)	300	635
JBS-630	795	614	535	11 (M10)	300	705
JBS-710	875	694	590	16 (M14)	300	785
JBS-905	1065	884	750	16 (M14)	400	975
JBS-1100	1260	1079	840	16 (M14)	400	1170

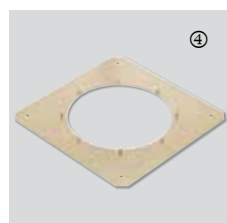

**JPA**  
**Accessory adapter plate**  
- Used when mounting the accessories (JCA, JBR, JAE).  
- Allows the fan to be disconnected from the upstand without having to remove the duct.

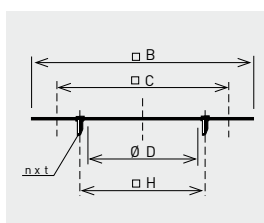

Model	□B	□C	Ø D	n x t	Ø H
JPA-300	289	245	182	4xM6	205
JPA-435	419	330	252	4xM8	280
JPA-560	544	450	358	8xM8	395
JPA-630	614	535	403	8xM10	450
JPA-710	694	590	503	12xM10	560
JPA-905	884	750	633	12xM10	690
JPA-1100	1079	840	713	16xM10	770



**JCA**  
**Backdraft shutter**  
- Prevents backdraft when the fan is not operating.  
- To be mounted at the fan inlet with the JPA plate.

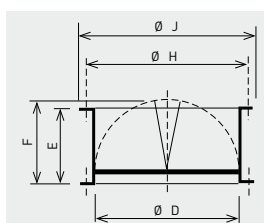

Model	Ø D	E	F	Ø H	Ø J
JCA-300	182	100	124	205	219
JCA-435	252	145	174	280	300
JCA-560-N	358	210	227	395	415
JCA-630-N	403	240	250	450	474
JCA-710-N	503	285	300	560	581
JCA-905-N	633	345	365	690	714
JCA-1100-N	713	390	410	770	806



**JBR**  
**Flange**  
- For use when circular connection is required directly to the fan.  
- To be mounted at the fan inlet with the JPA plate or fixed directly to the fan base (rivets or screws not supplied).

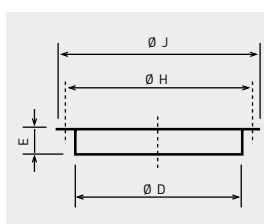

Model	Ø D	E	Ø H	Ø J
JBR-300 N	182	55	205	219
JBR-435 N	252	55	280	300
JBR-560 N	358	55	395	415
JBR-630 N	403	63	450	474
JBR-710 N	503	69	560	581
JBR-905 N	633	69	690	714
JBR-1100 N	713	69	770	797



**JAE**  
**Flexible coupling**  
- Reduces the transmission of vibrations when the duct is connected directly to the fan.  
- To be mounted at the fan inlet with JPA plate.

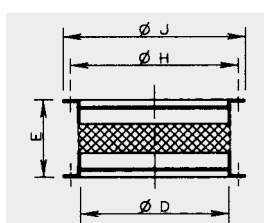

Model	Ø D	E	Ø H	Ø J
JAE-300 N	182	254	205	219
JAE-435 N	252	254	280	300
JAE-560 N	358	254	395	415
JAE-630 N	403	254	450	474
JAE-710 N	503	254	560	581
JAE-905 N	633	254	690	714
JAE-1100 N	713	254	770	797



**JCC**  
**Adapter for circular duct**  
- For use when fitting the models up to 400, directly to a spirally wound circular duct.

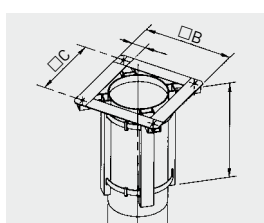

Model	Ø B	Ø C	Ø D	E	L
JCC-300	290	245	180	45	350
JCC-435	390	330	250	60	350
JCC-560	520	450	355	70	350
JCC-630	605	535	400	70	350



**MOUNTING ACCESSORIES**



**BI Support base for inclined curb mounted installations**  
 - To ensure a proper installation of the MAXTEMP roof fan it is essential to specify the roof pitch angle and the distance between the roof beam profiles.

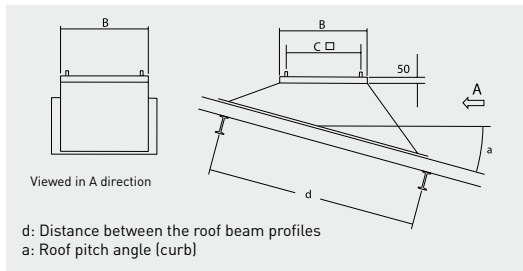

Model	B	C
BI-3	289	245
BI-4	419	330
BI-5	544	450
BI-6	614	535
BI-7	694	590
BI-9	884	750
BI-11	1079	840



**JAA Acoustic up stand**  
 - Reduces in duct and radiated noise.  
 - For use when mounting a fan on a flat roof without up stands.  
 - Supplied with screws and gasket for a complete weather seal.

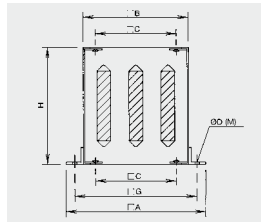

Model	□A	□B	□C	Ø D (M)	H	□G
JAA-300	470	290	245	13 (M10)	750	380
JAA-435	600	419	330	15 (M12)	750	510
JAA-560	725	545	450	15 (M12)	750	635
JAA-630	795	615	535	15 (M12)	750	705
JAA-710	875	695	590	18 (M14)	1000	785
JAA-905	1065	885	750	18 (M14)	1000	975
JAA-1100	1260	1080	840	18 (M14)	1000	1170

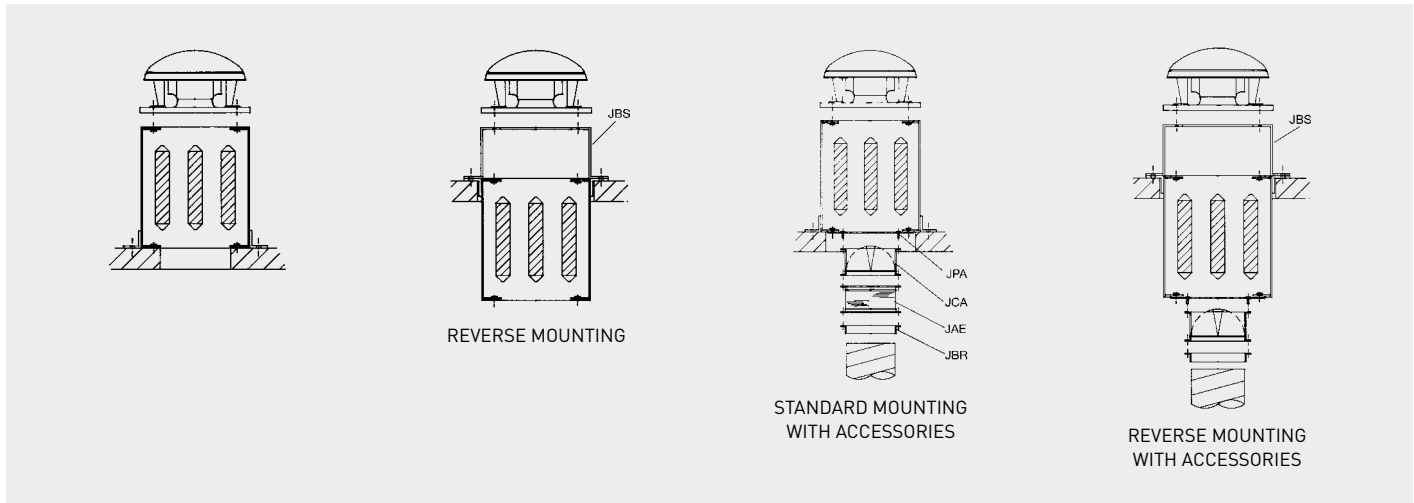

Acoustic attenuation in dB(A) at the corresponding frequency band in Hz.

Model	125	250	500	1000	2000	4000	8000
JAA-300	1	5	13	22	23	16	12
JAA-435	1	7	16	23	25	18	13
JAA-560	2	8	16	29	32	26	17
JAA-630	2	8	14	24	27	19	13
JAA-710	2	8	14	24	28	16	11
JAA-905	2	7	14	26	30	19	12
JAA-1100	2	7	16	27	32	20	13

JAA Attenuator pressure drops.

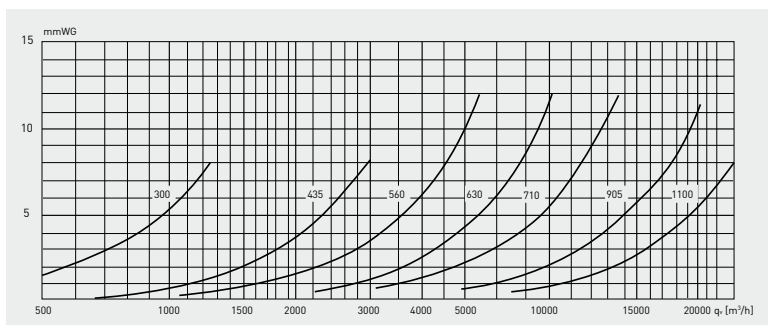

INSTALLATION

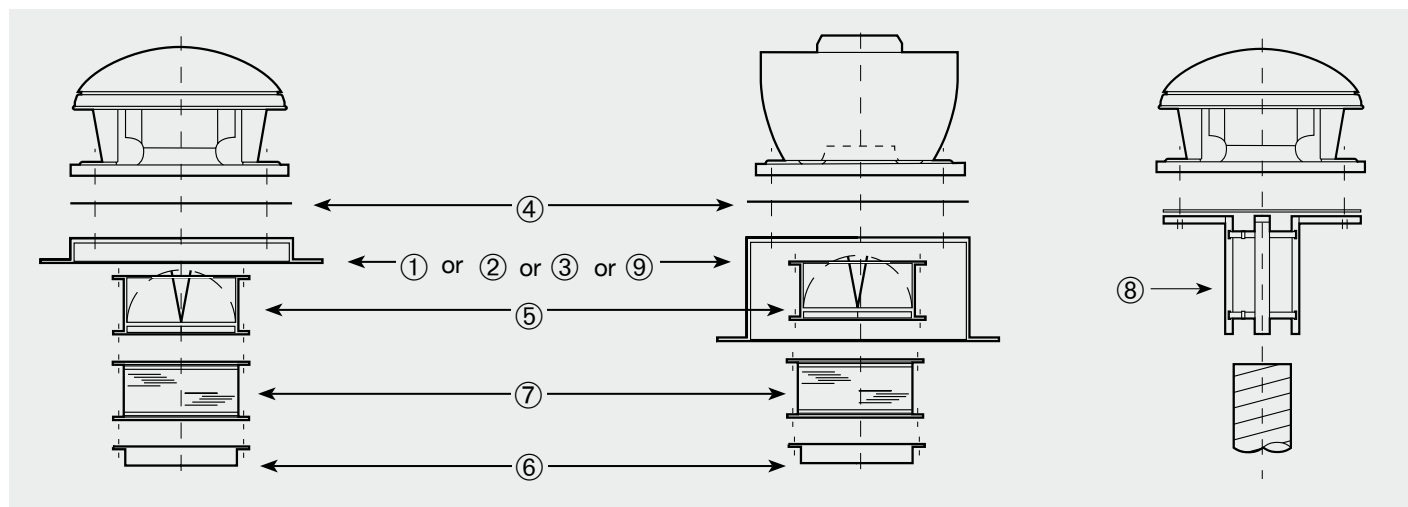

Fan model	① Sealing frame	② Flat roof insulated up stand	③ Acoustic up stand	④ Accessory adapter plate	⑤ Back draft shutter	⑥ Flange with spigot	⑦ Flexible coupling	⑧ Circular adapter	⑨ Support base for inclined curb mounted installations
140 180	JMS-300	JBS-300	JAA-300	JPA-300	JCA-300	JBR-300 N	JAЕ-300 N	JCC-300	BI-3
200 225	JMS-435	JBS-435	JAA-435	JPA-435	JCA-435	JBR-435 N	JAЕ-435 N	JCC-435	BI-4
250 315	JMS-560	JBS-560	JAA-560	JPA-560	JCA-560-N	JBR-560 N	JAЕ-560 N	JCC-560	BI-5
400	JMS-630	JBS-630	JAA-630	JPA-630	JCA-630-N	JBR-630 N	JAЕ-630 N	JCC-630	BI-6
450	JMS-710	JBS-710	JAA-710	JPA-710	JCA-710-N	JBR-710 N	JAЕ-710 N	-	BI-7
500 560	JMS-905	JBS-905	JAA-905	JPA-905	JCA-905-N	JBR-905 N	JAЕ-905 N	-	BI-9
630 710	JMS-1100	JBS-1100	JAA-1100	JPA-1100	JCA-1100-N	JBR-1100 N	JAЕ-1100 N	-	BI-11

ELECTRICAL ACCESSORIES



**REB**  
Single phase electronic speed controllers.  
- For use with the single phase roof fans.



**REB-5 / REB-10**  
Single phase electronic speed controllers.  
- For use with the single phase roof fans phase roof fans.



**RMB / RMT**  
Auto transformer speed controllers.  
- For single phase and three phase roof fans models from 140 to 400.



**On/ Off Electrical isolation switch**  
- Switch On/ Off 5P [1 speed motor]  
- Switch On/ Off 8P [2 speed motor].



**COM D/S Switch**  
- To connect three phase fans with 400 V motor.  
- For three phase roof fans models from 140 to 400.



**DEMA DH**  
Switch for 2-speed motors with Dahlander.



**VFTM IP54**  
Adjustable frequency drives for three phase motors from 0,37 to 15 kW.



**VFKB IP65**  
Adjustable frequency drive for three phase motors from 0,37 to 4 kW.