



Range of in-line fans for circular ducts, designed for high aerodynamic performances with a very compact profiles and very low sound levels. The range comprises five diameters and covers a flow range from 260 to 1080 m³/h.

Low profile compact casing manufactured from galvanised sheet steel. The terminal box and the mounting bracket do not increase the product's profile.

Optimised design of the impeller, guide vane and outlet diffuser, manufactured from injection-moulded plastic, to increase performance and lower the sound level.

Airtight joint between the galvanised steel casing and the plastic guide vane to avoid air leaks. Rubber gaskets on the flanges to improve airtightness with the ducts. Silent-block between the motor and the holder to reduce the motor's vibrations and lower the sound level of the installation, even in terms of speed regulation.

Motor

Fitted with an external rotor single-phase AC motor:

- 220-240V 50/60Hz, Class F, IP 44
- Speed controllable by voltage.
- Thermal protection with manual reset.
- Working temperature: -20/60 °C

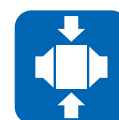

DESIGNED FOR AN EASY INSTALLATION



Terminal box
 Built-in, IP65 terminal box that does not add to the overall height dimensions.



Airtight joints
 Rubber gaskets for a more airtight joint with the installation's ducts.



High performance Impeller
 New impeller geometry for reduced sound levels and to offer high performance.

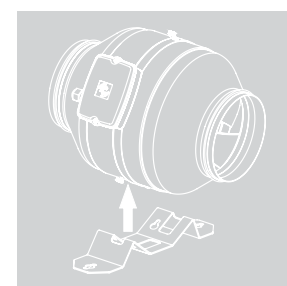

Mounting bracket
 Strong mounting bracket supplied with the fan.

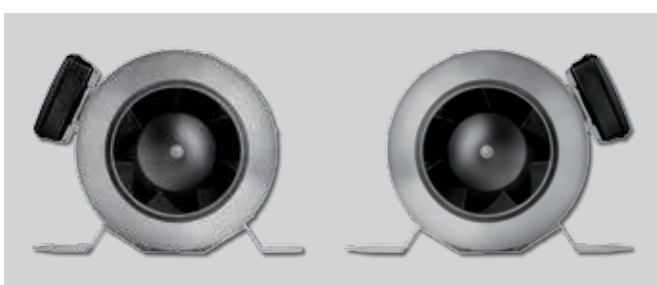

Two mounting positions for support

The product can be mounted in two different positions by changing the position of the support's anchoring.

TECHNICAL CHARACTERISTICS

Before installation check that the product electrical characteristics listed on the data plate label (voltage, power, frequency, etc.) match those of the intended electrical supply.

Model type	Speed (rpm)	Maximum absorbed power (W)	Maximum absorbed current (A-230V)	Maximum air volume (m ³ /h)	Sound pressure level* (dB(A))			Max. Air temp. (°C at 50Hz)	Weight (kg)	Speed controller	
					Inlet	Radiated	Outlet			REB	RMB
JETLINE-100	2690	19	0,10	260	41	22	39	-20/+60	3	REB-1 N	RMB-1,5
JETLINE-125	2640	40	0,20	420	47	25	47	-20/+60	3,4	REB-1 N	RMB-1,5
JETLINE-150	2730	83	0,40	750	52	31	50	-20/+60	4,5	REB-1 N	RMB-1,5
JETLINE-160	2730	84	0,40	760	52	31	51	-20/+60	4,5	REB-1 N	RMB-1,5
JETLINE-200	2630	125	0,50	1080	58	42	55	-20/+60	5,6	REB-1 N	RMB-1,5

* sound pressure level measured at 1,5 m in free field condition, at the duty point 2 of the performance curve.

DIMENSIONS (mm)

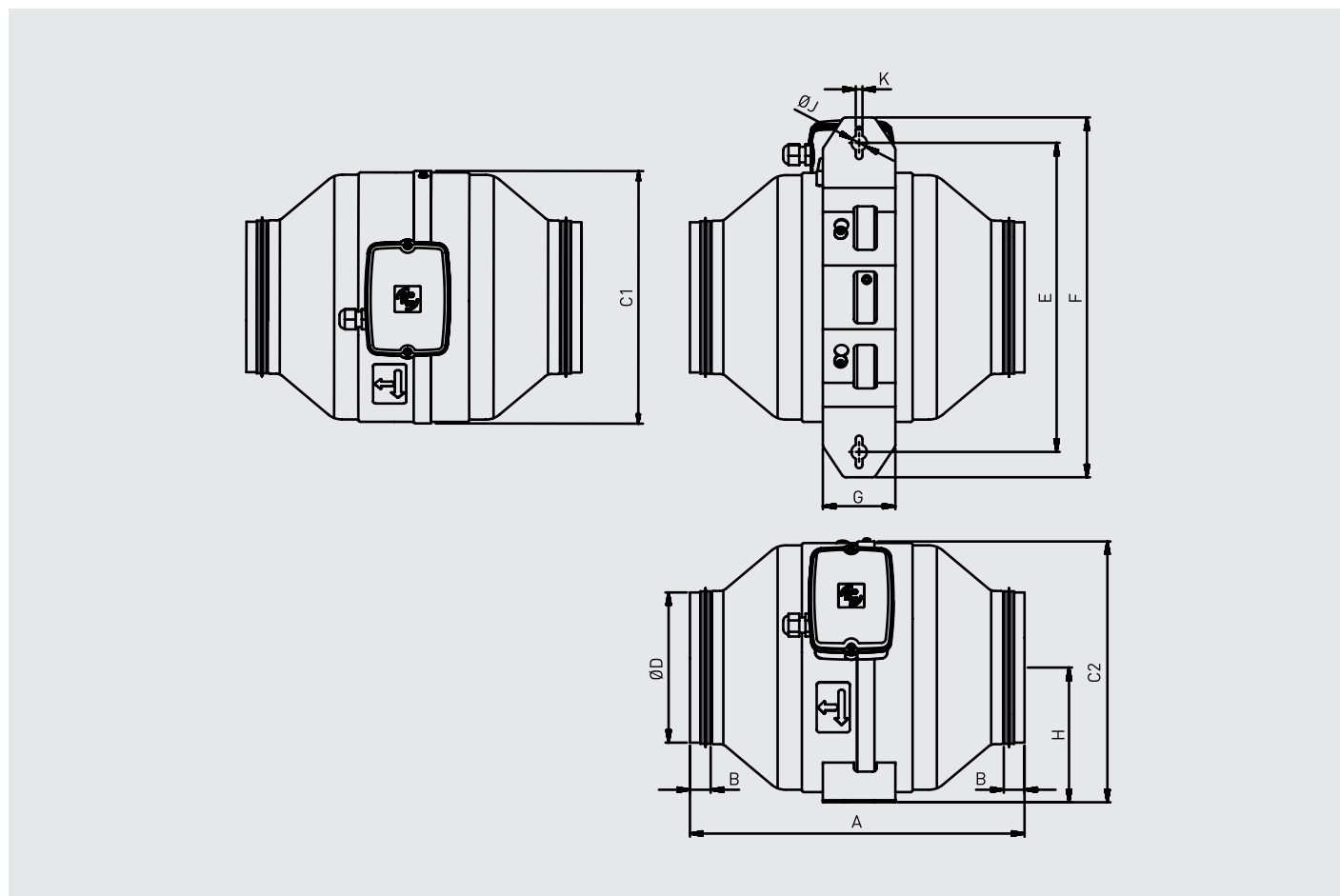

Model	A	B	C1	C2	ØD	E	F	G	H	ØJ	K
JETLINE-100	276	15	181	190	95	256	306	70	98	15	6,5
JETLINE-125	279	15	206	214	120	265	315	70	111	15	6,5
JETLINE-150	323	20	244	252	145	299	348	70	130	15	6,5
JETLINE-160	323	20	244	252	155	299	348	70	130	15	6,5
JETLINE-200	322	30	273	281	195	320	369	100	144,5	15	6,5

PERFORMANCE CURVES - ACOUSTIC CHARACTERISTICS

- q_v : Airflow in m^3/h .
- p_{sf} : Static pressure in Pa.
- P: Input power in W.
- SFP: Specific fan power in $W/m^3/s$ (blue curves).
- Performance data in accordance with ISO 5801.

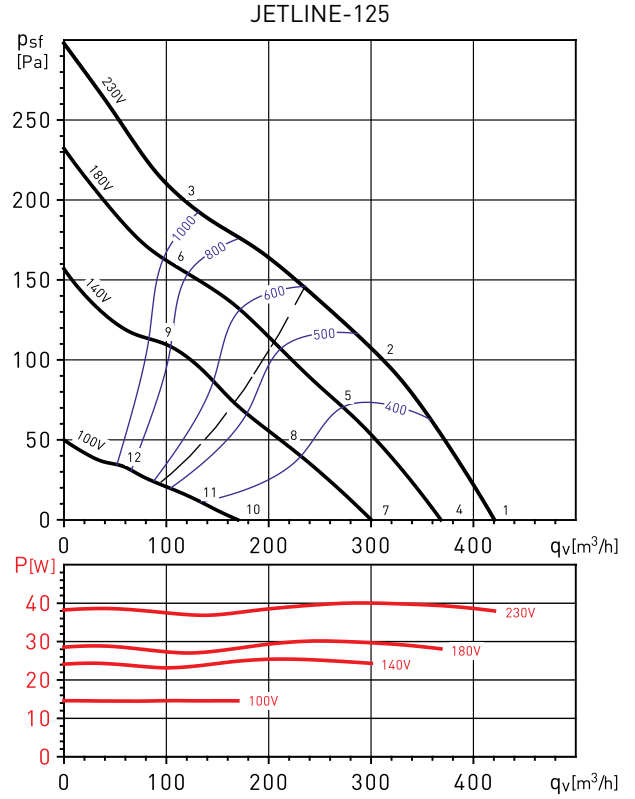
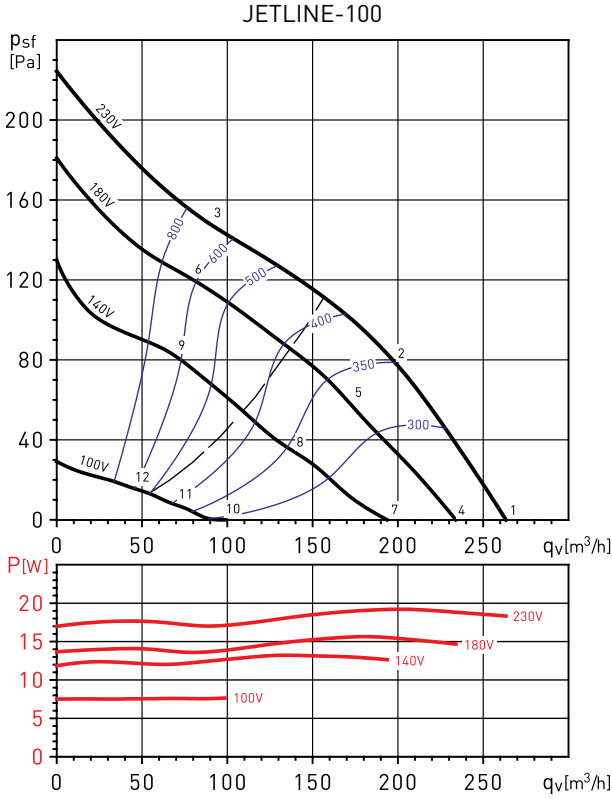

Sound power spectrum (dB(A))

Working point	63	125	250	500	1000	2000	4000	8000	LwA	
1	INLET	30	33	44	50	54	51	51	36	58
	OUTLET	27	32	45	49	50	49	46	34	55
	BREAK-OUT	19	15	23	27	35	34	34	19	40
2	INLET	27	31	42	47	51	48	48	34	55
	OUTLET	27	32	44	47	48	46	46	34	53
	BREAK-OUT	16	13	21	24	32	31	31	17	37
3	INLET	29	39	51	52	56	51	50	36	60
	OUTLET	29	41	53	51	53	49	47	35	58
	BREAK-OUT	18	21	30	29	37	34	33	19	41
4	INLET	27	30	41	47	51	48	48	33	55
	OUTLET	24	29	42	46	47	46	43	31	53
	BREAK-OUT	16	12	20	24	32	31	31	16	37
5	INLET	24	28	39	44	48	45	45	31	52
	OUTLET	24	29	41	44	45	43	43	31	50
	BREAK-OUT	13	10	18	21	29	28	28	14	33
6	INLET	27	37	49	50	54	49	48	34	57
	OUTLET	27	39	51	49	51	47	45	33	56
	BREAK-OUT	16	19	28	27	35	32	31	17	38
7	INLET	23	26	37	43	47	44	44	29	51
	OUTLET	20	25	38	42	43	42	39	27	48
	BREAK-OUT	12	8	16	20	28	27	27	12	32
8	INLET	18	22	33	38	42	39	39	25	47
	OUTLET	18	23	35	38	39	37	37	25	45
	BREAK-OUT	7	4	12	15	23	22	22	8	28
9	INLET	23	33	45	46	50	45	44	30	53
	OUTLET	23	35	47	45	47	43	41	29	52
	BREAK-OUT	12	15	24	23	31	28	27	13	34

Sound power spectrum (dB(A))

Working point	63	125	250	500	1000	2000	4000	8000	LwA	
1	INLET	41	38	52	63	55	56	52	43	65
	OUTLET	29	45	52	61	56	56	54	41	64
	BREAK-OUT	31	25	27	37	34	35	33	25	42
2	INLET	40	37	50	58	52	54	51	41	61
	OUTLET	28	47	48	58	54	54	54	39	62
	BREAK-OUT	30	24	25	32	31	33	32	23	39
3	INLET	43	46	59	63	57	56	53	42	66
	OUTLET	31	52	53	61	58	56	57	40	65
	BREAK-OUT	33	33	34	37	36	35	34	24	43
4	INLET	39	36	50	61	53	54	50	41	62
	OUTLET	27	43	50	59	54	54	52	39	62
	BREAK-OUT	29	23	25	35	32	33	31	23	39
5	INLET	37	34	47	55	49	51	48	38	58
	OUTLET	25	44	45	55	51	51	51	36	59
	BREAK-OUT	27	21	22	29	28	30	29	20	36
6	INLET	41	44	57	61	55	54	51	40	64
	OUTLET	29	50	51	59	56	54	55	38	63
	BREAK-OUT	31	31	32	35	34	33	32	22	41
7	INLET	34	31	45	56	48	49	45	36	58
	OUTLET	22	38	45	54	49	49	47	34	57
	BREAK-OUT	24	18	20	30	27	28	26	18	35
8	INLET	32	29	42	50	44	46	43	33	53
	OUTLET	20	39	40	50	46	46	46	31	54
	BREAK-OUT	22	16	17	24	23	25	24	15	31
9	INLET	37	40	53	57	51	50	47	36	60
	OUTLET	25	46	47	55	52	50	51	34	59
	BREAK-OUT	27	27	28	31	30	29	28	18	37

PERFORMANCE CURVES - ACOUSTIC CHARACTERISTICS

- q_v : Airflow in m^3/h .
- p_{sf} : Static pressure in Pa.
- P: Input power in W.
- SFP: Specific fan power in $W/m^3/s$ (blue curves).
- Performance data in accordance with ISO 5801.

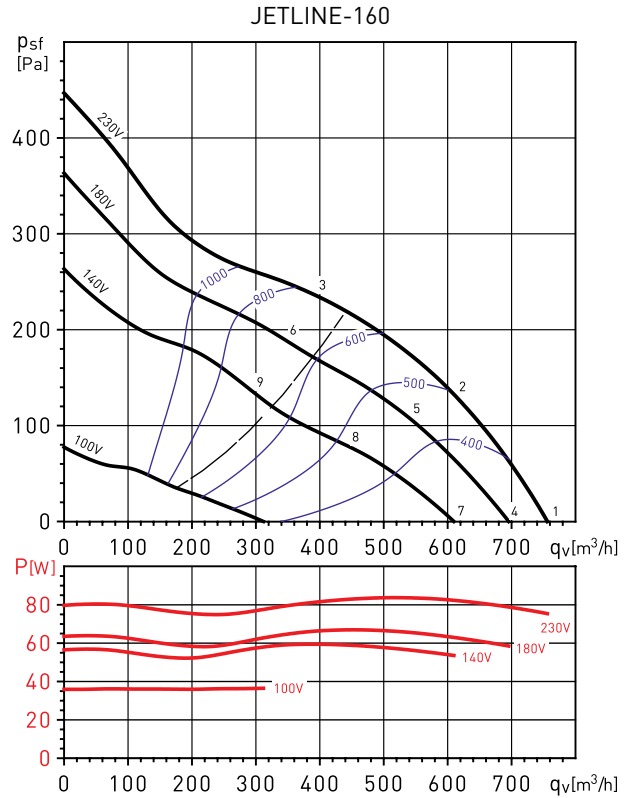
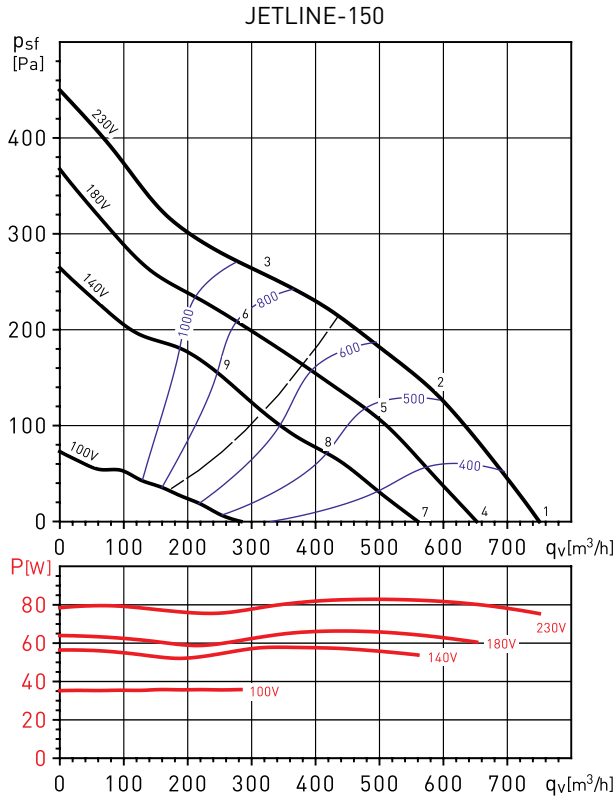

Sound power spectrum (dB(A))

Working point		63	125	250	500	1000	2000	4000	8000	LwA
1	INLET	29	40	58	62	59	61	59	50	67
	OUTLET	40	43	57	62	59	59	57	46	66
	BREAK-OUT	14	27	34	39	39	41	42	33	47
2	INLET	28	39	58	62	58	60	57	49	66
	OUTLET	28	43	56	61	57	58	55	44	65
	BREAK-OUT	13	26	34	39	38	40	40	32	46
3	INLET	34	43	53	61	57	60	55	47	65
	OUTLET	31	46	55	61	57	58	53	42	65
	BREAK-OUT	19	30	29	38	37	40	38	30	45
4	INLET	27	38	56	60	57	59	57	48	65
	OUTLET	38	41	55	60	57	57	55	44	65
	BREAK-OUT	12	25	32	37	37	39	40	31	45
5	INLET	26	37	56	60	56	58	55	47	65
	OUTLET	26	41	54	59	55	56	53	42	63
	BREAK-OUT	11	24	32	37	36	38	38	30	44
6	INLET	32	41	51	59	55	58	53	45	64
	OUTLET	29	44	53	59	55	56	51	40	63
	BREAK-OUT	17	28	27	36	35	38	36	28	43
7	INLET	24	35	53	57	54	56	54	45	62
	OUTLET	35	38	52	57	54	54	52	41	61
	BREAK-OUT	9	22	29	34	34	36	37	28	42
8	INLET	22	33	52	56	52	54	51	43	61
	OUTLET	22	37	50	55	51	52	49	38	59
	BREAK-OUT	7	20	28	33	32	34	34	26	40
9	INLET	29	38	48	56	52	55	50	42	61
	OUTLET	26	41	50	56	52	53	48	37	60
	BREAK-OUT	14	25	24	33	32	35	33	25	40

Sound power spectrum (dB(A))

Working point		63	125	250	500	1000	2000	4000	8000	LwA
1	INLET	38	49	54	63	60	62	64	52	69
	OUTLET	39	42	56	63	59	59	60	51	67
	BREAK-OUT	24	14	23	35	38	40	47	38	49
2	INLET	36	47	54	62	58	60	60	49	67
	OUTLET	44	42	55	62	58	58	57	47	66
	BREAK-OUT	22	12	23	34	36	38	43	35	46
3	INLET	38	45	54	61	56	60	57	47	65
	OUTLET	45	46	55	61	57	58	55	45	65
	BREAK-OUT	24	10	23	33	34	38	40	33	44
4	INLET	36	47	52	61	58	60	62	50	67
	OUTLET	37	40	54	61	57	57	58	49	65
	BREAK-OUT	22	12	21	33	36	38	45	36	47
5	INLET	34	45	52	60	56	58	58	47	64
	OUTLET	42	40	53	60	56	56	55	45	64
	BREAK-OUT	20	10	21	32	34	36	41	33	43
6	INLET	36	43	52	59	54	58	55	45	63
	OUTLET	43	44	53	59	55	56	53	43	63
	BREAK-OUT	22	8	21	31	32	36	38	31	42
7	INLET	34	45	50	59	56	58	60	48	64
	OUTLET	35	38	52	59	55	55	56	47	63
	BREAK-OUT	20	10	19	31	34	36	43	34	44
8	INLET	30	41	48	56	52	54	54	43	61
	OUTLET	38	36	49	56	52	52	51	41	60
	BREAK-OUT	16	6	17	28	30	32	37	29	40
9	INLET	32	39	48	55	50	54	51	41	60
	OUTLET	39	40	49	55	51	52	49	39	59
	BREAK-OUT	18	4	17	27	28	32	34	27	38

PERFORMANCE CURVES - ACOUSTIC CHARACTERISTICS

- q_v : Airflow in m^3/h .
- p_{sf} : Static pressure in Pa.
- P: Input power in W.
- SFP: Specific fan power in $W/m^3/s$ (blue curves).
- Performance data in accordance with ISO 5801.

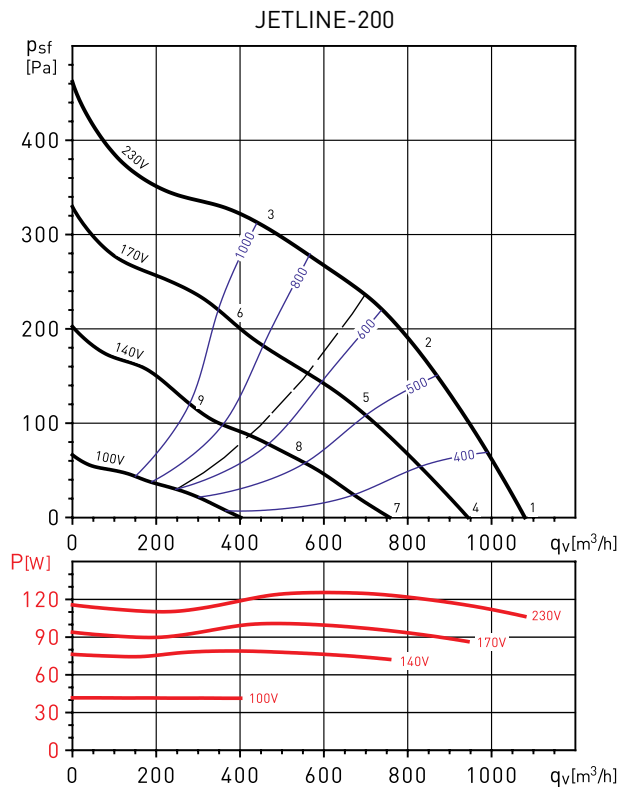

Sound power spectrum (dB(A))

Working point		63	125	250	500	1000	2000	4000	8000	LwA
1	INLET	29	44	60	65	65	64	65	60	72
	OUTLET	28	45	61	65	64	63	62	56	71
	BREAK-OUT	18	36	48	50	50	46	49	42	56
2	INLET	30	40	56	66	68	64	62	57	72
	OUTLET	28	44	57	64	65	62	58	53	69
	BREAK-OUT	19	33	44	51	53	46	45	39	56
3	INLET	41	51	63	68	70	68	61	54	74
	OUTLET	39	55	63	66	67	67	59	51	72
	BREAK-OUT	30	44	52	53	54	49	44	36	59
4	INLET	26	41	57	62	63	62	62	57	69
	OUTLET	25	42	58	62	62	60	59	53	68
	BREAK-OUT	15	33	45	47	47	43	46	40	53
5	INLET	25	36	52	62	64	60	58	52	68
	OUTLET	23	40	52	60	61	58	54	48	65
	BREAK-OUT	15	28	40	47	49	42	41	35	52
6	INLET	37	47	60	64	66	64	57	50	70
	OUTLET	35	51	59	62	63	63	55	47	68
	BREAK-OUT	26	40	48	49	50	45	40	32	55
7	INLET	22	36	53	58	58	57	58	53	64
	OUTLET	21	37	54	58	57	56	55	48	63
	BREAK-OUT	11	29	41	43	43	39	41	35	49
8	INLET	20	30	46	56	58	54	52	47	62
	OUTLET	17	34	47	54	55	52	48	43	59
	BREAK-OUT	9	23	34	41	43	36	35	29	46
9	INLET	31	42	54	58	60	58	51	44	64
	OUTLET	29	45	53	57	57	57	50	41	63
	BREAK-OUT	20	34	42	43	45	40	35	26	49

MOUNTING ACCESSORIES



MBE
 Electric heater.



MBW
 Hot water coil.



SIL
 Circular sound attenuators.



MFL-G4
 Filtration box of G4 grade filtration.



MFL-F
 Box in galvanized steel for inserting the MFR F5, F6 and F7 filters.



CAR
 Backdraught shutters.



GSA M0
 Aluminium flexible ducting.



GSI M0
 Insulated aluminium ducting.



CX
 Worm drive duct connectors.



BOC
 Metal inlet valves.



BOR
 Plastic inlet valves.



GCI
 Circular inlet grilles.



VR
 GCI mounting frame.



GRI
 Interior square grilles.

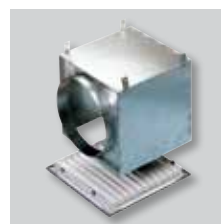

RP
 GRI mounting frame.