



Range of direct drive backward curved centrifugal cabinet fans designed for ventilation of commercial kitchens and industrial applications.

Available in nine sizes with performance from 1.370 to 15.700 m³/h.

Cabinet fan manufactured from aluminium profiles and panel manufactured from galvanised steel sheet lined with melamine foam flame retardant acoustic insulation. Circular duct connection flange on the inlet CVAT incorporates direct drive backward curved centrifugal impeller with motor fitted inside the air stream.

Motors

All the motors are IP55, Class F insulation, with thermal protection (PTC), speed controllable by inverter.

Electrical supply:

Three phase 230/400V-50Hz in 6 pole. Working temperature from -20°C to +40°C.

On request

Double thickness side panels lined with 25 mm thickness of fireproof fiberglass acoustic insulation.

ATEX versions

On request, explosion proof versions in accordance to ATEX Directive, for three phase models.

Working temperature from -20°C to +40°C.

- ATEX Flameproof - Gas

⊕ II 2G Exd IIC T4

⊕ II 2G Exd IIB T5

- ATEX Increased safety - Gas

⊕ II 2G Exe IIC T3

To select CVAT-N ATEX refer to performance curves, or Easyvent.

Note electrical data may vary for ATEX motors.

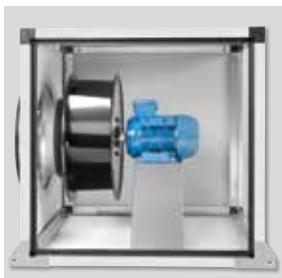

Backward curved centrifugal impellers

To prevent accumulation of dirtiness. Dynamically balanced.

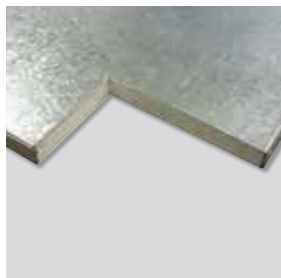

Low noise level

On request, double thickness side panels lined with 25 mm thickness of fireproof fiberglass acoustic insulation.



Robustness

Quality finished aluminium profiles and plastic corners providing a great robustness.

Specific applications



Industrial
kitchens



Versions

TECHNICAL CHARACTERISTICS

Before installation check that the product electrical characteristics listed on the data plate label (voltage, power, frequency, etc.) match those of the intended electrical supply.

Model	Speed (rpm)	Maximum absorbed power (W)	Maximum absorbed current (A)	Maximum airflow (m³/h)	Sound pressure level* (dB(A))			Weight (kg)
					Inlet	Radiated	Outlet	
CVAT/4-1400/250N 0,18	1480	116	0,5	1.370	51	50	45	13
CVAT/4-2000/315N 0,18	1465	169	0,5	2.020	54	55	46	13
CVAT/4-3000/355N 0,18	1445	251	0,5	2.880	59	55	44	30
CVAT/4-4000/400N 0,37	1450	438	0,9	4.190	63	61	49	32
CVAT/4-6000/450N 0,75	1470	747	1,7	6.030	63	64	52	46
CVAT/4-9000/500N 1,1	1480	1347	2,5	8.960	66	69	54	58
CVAT/4-12000/560N 2,2	1470	2093	4,2	11.960	70	71	57	82
CVAT/4-16000/630N 3	1465	3234	5,9	15.720	73	76	61	113
CVAT/6-15000/710N 1,5	975	1828	3,6	15.380	69	69	57	149

* Sound pressure level measured in free field condition at 1.5m, at the medium working point on the performance curve, shown 2, 5, 8 and 11.

Model	VFTM		VFKB	
	1-PHASE SUPPLY	3-PHASE SUPPLY	1-PHASE SUPPLY	3-PHASE SUPPLY
CVAT/4-1400/250N 0,18	VFTM MONO 0,18		VFKB-24	VFKB-45
CVAT/4-2000/315N 0,18	VFTM MONO 0,18		VFKB-24	VFKB-45
CVAT/4-3000/355N 0,18	VFTM MONO 0,18		VFKB-24	VFKB-45
CVAT/4-4000/400N 0,37	VFTM MONO 0,18	VFTM TRI 0,37	VFKB-24	VFKB-45
CVAT/4-6000/450N 0,75	VFTM MONO 0,37	VFTM TRI 0,75	VFKB-24	VFKB-45
CVAT/4-9000/500N 1,1	VFTM MONO 0,37	VFTM TRI 1,1	VFKB-24	VFKB-45
CVAT/4-12000/560N 2,2	VFTM MONO 0,75	VFTM TRI 2,2	VFKB-27	VFKB-48
CVAT/4-16000/630N 3	VFTM MONO 1,1	VFTM TRI 3	VFKB-27	VFKB-48
CVAT/6-15000/710N 1,5	VFTM MONO 0,55	VFTM TRI 1,5	VFKB-27	VFKB-48

PERFORMANCE CURVES - ACOUSTIC CHARACTERISTICS

- q_v : Airflow in m^3/h .
- p_{st} : Static pressure in Pa.
- P: Input power in W.
- SFP: Specific fan power in $W/m^3/s$ (blue curves).
- Performance data in accordance with ISO 5801 and AMCA 210-99 Standards.

CVAT/4-1400/250N 0,18kW

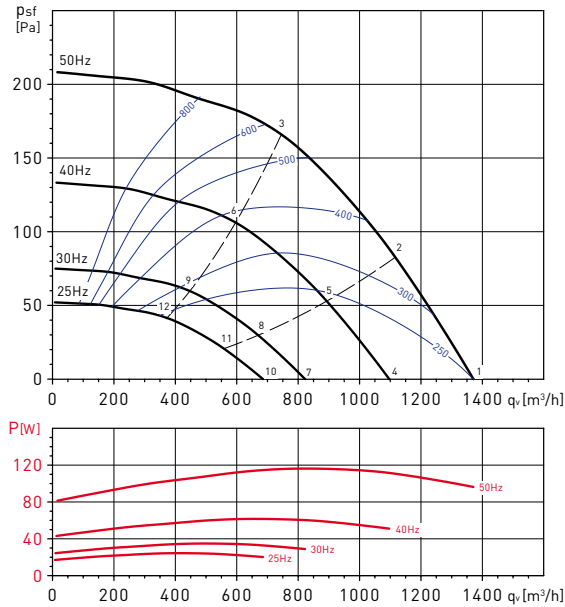

CVAT/4-2000/315N 0,18kW

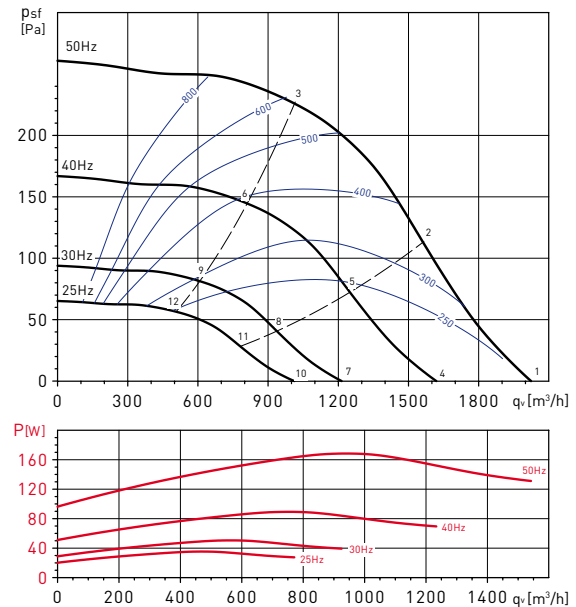

Working point		63	125	250	500	1000	2000	4000	8000	LwA
1	Inlet	37	52	61	62	61	59	58	51	68
	Outlet	35	50	58	58	63	60	52	42	67
	Break-Out	33	42	47	49	60	52	41	30	61
2	Inlet	37	50	59	60	59	55	53	47	65
	Outlet	34	48	56	57	61	57	49	36	64
	Break-Out	33	40	45	47	58	49	38	23	59
3	Inlet	37	47	57	58	58	53	50	42	63
	Outlet	33	45	54	55	60	52	47	35	63
	Break-Out	31	36	42	46	57	44	36	22	58
4	Inlet	32	47	56	57	56	54	53	46	63
	Outlet	30	45	53	53	58	55	47	37	62
	Break-Out	29	37	42	44	55	48	36	25	56
5	Inlet	32	45	54	55	54	50	48	42	60
	Outlet	29	43	51	52	56	52	44	31	60
	Break-Out	28	35	40	43	54	44	33	18	55
6	Inlet	32	42	52	53	53	48	45	37	58
	Outlet	28	40	49	50	55	47	42	30	58
	Break-Out	26	31	37	41	52	40	31	17	53
7	Inlet	26	41	50	51	50	48	47	40	57
	Outlet	24	39	47	47	52	49	41	31	55
	Break-Out	22	30	36	38	49	41	30	19	50
8	Inlet	26	39	48	49	48	44	42	36	54
	Outlet	23	37	45	46	50	46	38	25	53
	Break-Out	21	29	34	36	47	38	27	12	48
9	Inlet	26	36	46	47	47	42	39	31	52
	Outlet	22	34	43	44	49	41	36	24	51
	Break-Out	20	25	31	35	46	33	25	11	47
10	Inlet	22	37	46	47	46	44	43	36	53
	Outlet	20	35	43	43	48	45	37	27	52
	Break-Out	18	26	32	34	45	37	26	15	46
11	Inlet	22	35	44	45	44	40	38	32	50
	Outlet	19	33	41	42	46	42	34	21	49
	Break-Out	17	25	30	32	43	34	23	8	44
12	Inlet	22	32	42	43	43	38	35	27	48
	Outlet	18	30	39	40	45	37	32	20	48
	Break-Out	16	21	27	31	42	29	21	7	43

Working point		63	125	250	500	1000	2000	4000	8000	LwA
1	Inlet	35	61	62	65	63	62	56	55	70
	Outlet	41	53	62	62	66	61	50	47	69
	Break-Out	29	53	47	53	59	47	40	37	61
2	Inlet	36	57	59	63	62	57	53	50	68
	Outlet	43	51	60	61	67	57	47	38	69
	Break-Out	29	49	45	51	59	42	37	32	60
3	Inlet	35	53	56	62	62	55	53	46	66
	Outlet	44	49	56	59	66	55	49	40	68
	Break-Out	29	45	42	50	58	50	37	28	60
4	Inlet	30	56	57	60	58	57	51	50	65
	Outlet	36	48	57	57	61	56	45	42	65
	Break-Out	24	48	42	48	54	42	35	32	56
5	Inlet	31	52	54	58	57	52	48	45	63
	Outlet	38	46	55	56	62	52	42	33	64
	Break-Out	24	44	40	46	54	37	32	27	55
6	Inlet	30	48	51	57	57	50	48	41	62
	Outlet	39	44	51	54	61	50	44	35	63
	Break-Out	24	40	37	45	54	46	32	24	55
7	Inlet	24	50	51	54	52	51	45	44	59
	Outlet	30	42	51	51	55	50	39	36	58
	Break-Out	18	42	36	41	48	36	29	26	50
8	Inlet	25	46	48	52	51	46	42	39	56
	Outlet	32	40	49	50	56	46	36	27	58
	Break-Out	18	38	33	40	47	31	26	21	49
9	Inlet	24	42	45	51	51	44	42	35	55
	Outlet	33	38	45	48	55	44	38	29	56
	Break-Out	18	34	31	38	47	39	26	17	49
10	Inlet	20	46	47	50	48	47	41	40	55
	Outlet	26	38	47	47	51	46	35	32	54
	Break-Out	14	38	32	37	44	32	25	22	46
11	Inlet	21	42	44	48	47	42	38	35	52
	Outlet	28	36	45	46	52	42	32	23	54
	Break-Out	14	34	29	36	43	27	22	17	45
12	Inlet	20	38	41	47	47	40	38	31	51
	Outlet	29	34	41	44	51	40	34	25	52
	Break-Out	14	30	27	34	43	35	22	13	45

PERFORMANCE CURVES - ACOUSTIC CHARACTERISTICS

- q_v : Airflow in m^3/h .
- p_{sf} : Static pressure in Pa.
- P: Input power in W.
- SFP: Specific fan power in $W/m^3/s$ (blue curves).
- Performance data in accordance with ISO 5801 and AMCA 210-99 Standards.

CVAT/4-3000/355N 0,18kW

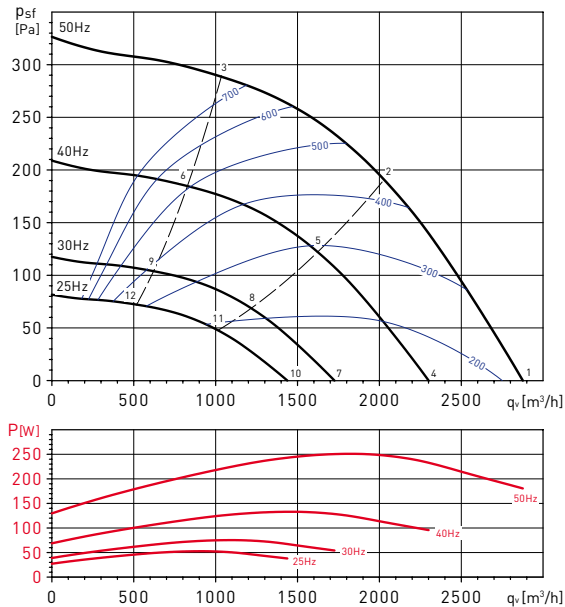

CVAT/4-4000/400N 0,37kW

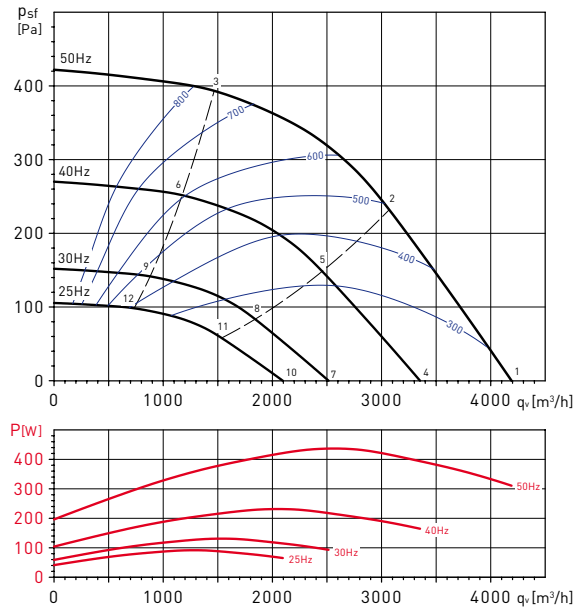

Working point		63	125	250	500	1000	2000	4000	8000	LwA
1	Inlet	38	67	68	71	67	68	62	61	76
	Outlet	46	64	65	64	67	65	55	52	72
	Break-Out	31	53	54	57	55	49	41	37	61
2	Inlet	40	65	65	68	64	62	59	55	73
	Outlet	35	58	61	62	65	58	53	47	69
	Break-Out	33	51	51	54	52	43	38	31	58
3	Inlet	45	65	66	68	63	60	58	54	72
	Outlet	42	57	61	62	63	56	52	46	68
	Break-Out	39	52	52	53	51	42	36	30	58
4	Inlet	33	62	63	66	62	63	57	56	71
	Outlet	41	59	60	59	62	60	50	47	67
	Break-Out	26	48	49	52	50	44	36	32	56
5	Inlet	35	60	60	63	59	57	54	50	68
	Outlet	30	53	56	57	60	53	48	42	64
	Break-Out	28	46	46	49	47	38	33	26	54
6	Inlet	40	60	61	63	58	55	53	49	68
	Outlet	37	52	56	57	58	51	47	41	63
	Break-Out	34	47	47	49	46	37	31	25	53
7	Inlet	27	56	57	60	56	57	51	50	65
	Outlet	35	53	54	53	56	54	44	41	61
	Break-Out	20	42	43	46	44	38	30	26	50
8	Inlet	29	54	54	57	53	51	48	44	61
	Outlet	24	47	50	51	54	47	42	36	58
	Break-Out	22	40	40	43	41	32	27	19	47
9	Inlet	34	54	55	57	52	49	47	43	61
	Outlet	31	46	50	51	52	45	41	35	57
	Break-Out	27	40	41	42	40	30	25	19	47
10	Inlet	23	52	53	56	52	53	47	46	61
	Outlet	31	49	50	49	52	50	40	37	57
	Break-Out	16	38	39	42	40	34	26	22	46
11	Inlet	25	50	50	53	49	47	44	40	57
	Outlet	20	43	46	47	50	43	38	32	54
	Break-Out	18	36	36	39	37	28	23	15	43
12	Inlet	30	50	51	53	48	45	43	39	57
	Outlet	27	42	46	47	48	41	37	31	53
	Break-Out	23	36	37	38	36	26	21	15	43

Working point		63	125	250	500	1000	2000	4000	8000	LwA
1	Inlet	51	73	73	77	70	74	67	61	81
	Outlet	51	73	73	77	70	74	67	61	81
	Break-Out	52	61	60	60	57	59	48	40	67
2	Inlet	46	71	69	73	67	67	64	56	77
	Outlet	55	68	66	68	69	64	59	55	75
	Break-Out	47	59	56	56	54	52	45	35	63
3	Inlet	53	68	68	71	65	64	61	57	75
	Outlet	53	64	64	69	68	63	58	55	74
	Break-Out	54	57	55	55	52	48	42	36	62
4	Inlet	46	68	68	72	65	69	62	56	76
	Outlet	46	68	68	72	65	69	62	56	76
	Break-Out	47	56	55	55	52	54	43	35	62
5	Inlet	41	66	64	68	62	62	59	51	72
	Outlet	50	63	61	63	64	59	54	50	70
	Break-Out	43	54	51	51	49	47	40	30	58
6	Inlet	48	63	63	66	60	59	56	52	70
	Outlet	48	59	59	64	63	58	53	50	69
	Break-Out	49	52	50	50	47	43	38	31	57
7	Inlet	40	62	62	66	59	63	56	50	70
	Outlet	40	62	62	66	59	63	56	50	70
	Break-Out	41	50	49	49	45	47	37	29	56
8	Inlet	35	60	58	62	56	56	53	45	66
	Outlet	44	57	55	57	58	53	48	44	63
	Break-Out	36	48	45	45	43	40	34	24	52
9	Inlet	42	57	57	60	54	53	50	46	64
	Outlet	42	53	53	58	57	52	47	44	62
	Break-Out	43	46	44	43	40	37	31	25	51
10	Inlet	36	58	58	62	55	59	52	46	66
	Outlet	36	58	58	62	55	59	52	46	66
	Break-Out	37	46	45	45	41	43	33	25	52
11	Inlet	31	56	54	58	52	52	49	41	62
	Outlet	40	53	51	53	54	49	44	40	59
	Break-Out	32	44	41	41	39	36	30	20	48
12	Inlet	38	53	53	56	50	49	46	42	60
	Outlet	38	49	49	54	53	48	43	40	58
	Break-Out	39	42	40	39	36	33	27	21	47

PERFORMANCE CURVES - ACOUSTIC CHARACTERISTICS

- q_v : Airflow in m^3/h .
- p_{sf} : Static pressure in Pa.
- P: Input power in W.
- SFP: Specific fan power in $W/m^3/s$ (blue curves).
- Performance data in accordance with ISO 5801 and AMCA 210-99 Standards.

CVAT/4-6000/450N 0,75kW

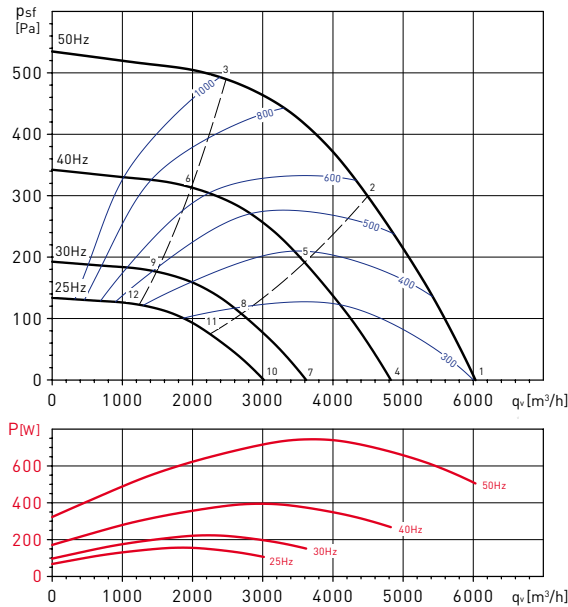

CVAT/4-9000/500N 1,1kW

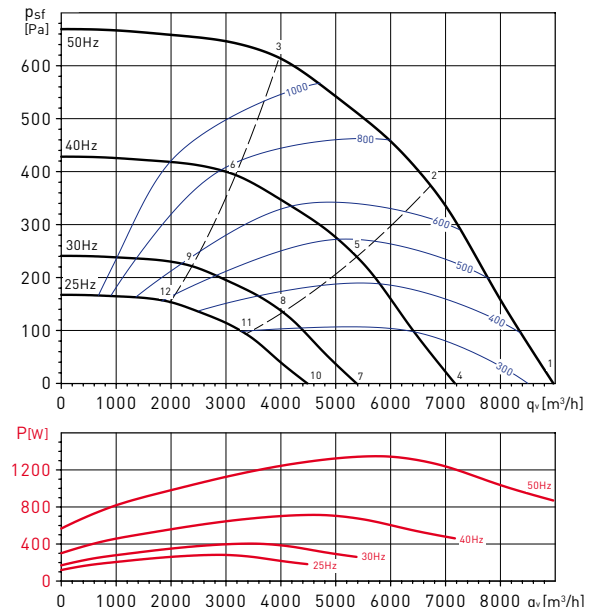

Working point	63	125	250	500	1000	2000	4000	8000	LwA	
1	Inlet	48	72	73	73	69	74	63	61	80
	Outlet	56	74	72	72	75	73	61	53	80
	Break-Out	44	58	64	61	61	60	49	44	68
2	Inlet	40	72	71	70	67	66	62	57	77
	Outlet	54	71	70	71	74	68	60	52	78
	Break-Out	36	59	62	58	58	52	48	40	66
3	Inlet	45	73	68	68	65	64	60	56	76
	Outlet	55	69	69	71	74	68	60	53	78
	Break-Out	41	60	59	56	56	49	46	39	64
4	Inlet	43	67	68	68	64	69	58	56	75
	Outlet	51	69	67	67	70	68	56	48	76
	Break-Out	39	53	59	56	56	55	44	39	63
5	Inlet	35	67	66	65	62	61	57	52	72
	Outlet	49	66	65	66	69	63	55	47	73
	Break-Out	31	54	57	53	53	47	43	35	61
6	Inlet	40	68	63	63	60	59	55	51	71
	Outlet	50	64	64	66	69	63	55	48	73
	Break-Out	36	55	54	51	51	45	41	34	59
7	Inlet	37	61	62	62	58	63	52	50	69
	Outlet	45	63	61	61	64	62	50	42	69
	Break-Out	33	47	53	50	50	49	38	33	57
8	Inlet	29	61	60	59	56	55	51	46	66
	Outlet	43	60	59	60	63	57	49	41	67
	Break-Out	25	47	51	47	47	41	37	29	55
9	Inlet	34	62	57	57	54	53	49	45	65
	Outlet	44	58	58	60	63	57	49	42	67
	Break-Out	30	49	48	45	45	38	35	28	53
10	Inlet	33	57	58	58	54	59	48	46	65
	Outlet	41	59	57	57	60	58	46	38	65
	Break-Out	29	43	49	46	46	45	34	29	53
11	Inlet	25	57	56	55	52	51	47	42	62
	Outlet	39	56	55	56	59	53	45	37	63
	Break-Out	21	43	47	43	43	37	33	25	51
12	Inlet	30	58	53	53	50	49	45	41	61
	Outlet	40	54	54	56	59	53	45	38	63
	Break-Out	26	45	44	41	41	34	31	24	49

Working point	63	125	250	500	1000	2000	4000	8000	LwA	
1	Inlet	51	74	78	77	74	78	69	62	84
	Outlet	61	76	76	77	80	75	68	57	84
	Break-out	45	59	68	62	63	59	48	36	70
2	Inlet	46	71	76	74	72	71	64	59	80
	Outlet	51	73	73	76	80	70	63	56	83
	Break-out	40	56	66	58	61	52	44	33	68
3	Inlet	47	71	73	71	71	69	64	61	78
	Outlet	52	71	69	74	79	68	62	56	81
	Break-out	41	57	63	55	59	51	44	35	66
4	Inlet	46	69	73	72	69	73	64	57	79
	Outlet	56	71	71	72	75	70	63	52	79
	Break-out	40	54	63	57	58	55	44	31	66
5	Inlet	41	66	71	69	67	66	59	54	76
	Outlet	46	68	68	71	75	65	58	51	78
	Break-out	36	51	61	54	56	47	39	28	63
6	Inlet	42	66	68	66	66	64	59	56	74
	Outlet	47	66	64	69	74	63	57	51	76
	Break-out	36	52	58	50	55	46	39	30	61
7	Inlet	40	63	67	66	63	67	58	51	73
	Outlet	50	65	65	66	69	64	57	46	73
	Break-out	34	48	57	51	52	48	37	25	59
8	Inlet	35	60	65	63	61	60	53	48	69
	Outlet	40	62	62	65	69	59	52	45	72
	Break-out	29	45	55	47	50	41	32	22	57
9	Inlet	36	60	62	60	60	58	53	50	67
	Outlet	41	60	58	63	68	57	51	45	70
	Break-out	30	45	52	44	48	40	33	24	55
10	Inlet	36	59	63	62	59	63	54	47	69
	Outlet	46	61	61	62	65	60	53	42	69
	Break-out	30	44	53	47	48	44	33	21	55
11	Inlet	31	56	61	59	57	56	49	44	65
	Outlet	36	58	58	61	65	55	48	41	68
	Break-out	25	41	51	43	46	37	28	18	53
12	Inlet	32	56	58	56	56	54	49	46	63
	Outlet	37	56	54	59	64	53	47	41	66
	Break-out	26	41	48	40	44	36	29	20	51

PERFORMANCE CURVES - ACOUSTIC CHARACTERISTICS

- q_v : Airflow in m^3/h .
- p_{sf} : Static pressure in Pa.
- P: Input power in W.
- SFP: Specific fan power in $W/m^3/s$ (blue curves).
- Performance data in accordance with ISO 5801 and AMCA 210-99 Standards.

CVAT/4-12000/560N 2,2kW

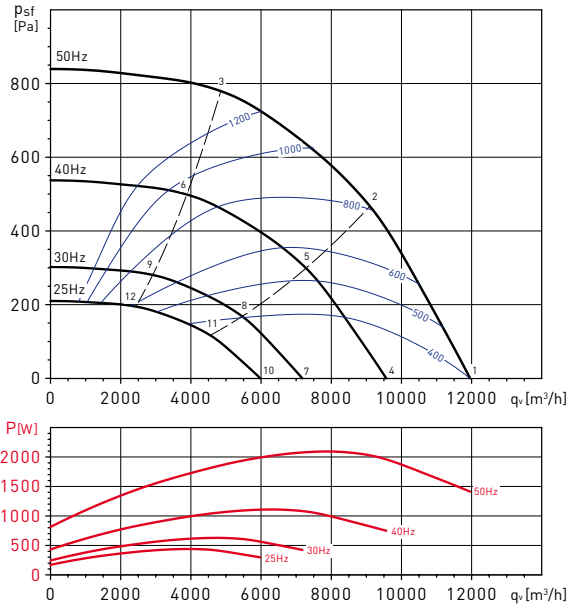

CVAT/4-16000/630N 3kW

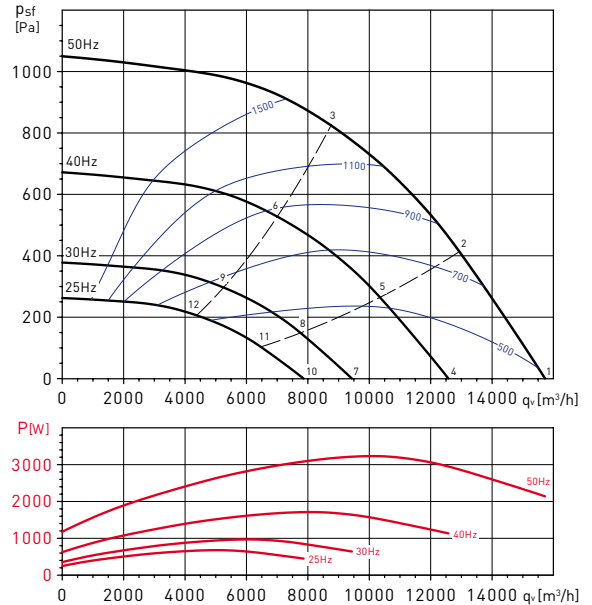

Working point		63	125	250	500	1000	2000	4000	8000	LwA
1	Inlet	57	77	82	81	80	80	78	74	88
	Outlet	66	78	81	81	83	77	75	62	88
	Break-Out	51	63	71	66	68	63	60	57	74
2	Inlet	52	75	79	78	77	75	69	66	84
	Outlet	57	76	77	79	81	72	67	59	85
	Break-Out	45	61	68	63	65	58	51	48	71
3	Inlet	53	76	76	75	73	72	67	63	82
	Outlet	58	77	74	76	78	69	65	58	83
	Break-Out	46	63	65	60	61	54	49	46	69
4	Inlet	52	72	77	76	75	75	73	69	83
	Outlet	61	73	76	76	78	72	70	57	83
	Break-Out	46	58	66	61	63	58	55	52	69
5	Inlet	47	70	74	73	72	70	64	61	79
	Outlet	52	71	72	74	76	67	62	54	80
	Break-Out	40	56	63	58	60	53	47	43	66
6	Inlet	48	71	71	70	68	67	62	58	77
	Outlet	53	72	69	71	73	64	60	53	78
	Break-Out	41	58	60	55	56	49	44	41	64
7	Inlet	46	66	71	70	69	69	67	63	77
	Outlet	55	67	70	70	72	66	64	51	77
	Break-Out	39	52	60	55	57	52	49	46	63
8	Inlet	41	64	68	67	66	64	58	55	73
	Outlet	46	65	66	68	70	61	56	48	74
	Break-Out	34	50	57	52	54	46	40	37	60
9	Inlet	42	65	65	64	62	61	56	52	71
	Outlet	47	66	63	65	67	58	54	47	72
	Break-Out	35	52	54	49	50	43	38	35	58
10	Inlet	42	62	67	66	65	65	63	59	73
	Outlet	51	63	66	66	68	62	60	47	73
	Break-Out	35	48	56	51	53	48	45	42	59
11	Inlet	37	60	64	63	62	60	54	51	69
	Outlet	42	61	62	64	66	57	52	44	70
	Break-Out	30	46	53	48	50	42	36	33	56
12	Inlet	38	61	61	60	58	57	52	48	67
	Outlet	43	62	59	61	63	54	50	43	68
	Break-Out	31	48	50	45	46	39	34	31	54

Working point		63	125	250	500	1000	2000	4000	8000	LwA
1	Inlet	59	79	81	79	80	87	74	66	90
	Outlet	67	80	82	87	87	86	75	64	92
	Break-Out	54	73	68	66	69	72	57	47	77
2	Inlet	56	77	81	79	80	80	72	66	87
	Outlet	68	76	81	86	85	78	70	62	90
	Break-Out	51	71	68	66	69	64	55	47	75
3	Inlet	68	76	82	78	80	78	72	67	87
	Outlet	68	74	79	84	84	74	66	60	88
	Break-Out	62	70	70	66	69	62	55	48	75
4	Inlet	54	74	76	74	75	82	69	61	85
	Outlet	62	75	77	82	82	81	70	59	87
	Break-Out	49	68	63	61	64	67	52	42	72
5	Inlet	51	72	76	74	75	75	67	61	82
	Outlet	63	71	76	81	80	73	65	57	85
	Break-Out	46	66	63	62	64	59	50	42	70
6	Inlet	63	71	77	73	75	73	67	62	82
	Outlet	63	69	74	79	79	69	61	55	83
	Break-Out	57	65	65	61	64	57	50	43	70
7	Inlet	48	68	70	68	69	76	63	55	79
	Outlet	56	69	71	76	76	75	64	53	81
	Break-Out	43	61	57	55	58	60	46	36	66
8	Inlet	45	66	70	68	69	69	61	55	76
	Outlet	57	65	70	75	74	67	59	51	79
	Break-Out	40	59	57	55	58	53	44	36	64
9	Inlet	57	65	71	67	69	67	61	56	75
	Outlet	57	63	68	73	73	63	55	49	77
	Break-Out	51	59	58	54	58	51	44	37	64
10	Inlet	44	64	66	64	65	72	59	51	75
	Outlet	52	65	67	72	72	71	60	49	77
	Break-Out	39	57	53	51	54	56	42	32	62
11	Inlet	41	62	66	64	65	65	57	51	72
	Outlet	53	61	66	71	70	63	55	47	75
	Break-Out	36	55	53	51	54	49	40	32	60
12	Inlet	53	61	67	63	65	63	57	52	71
	Outlet	53	59	64	69	69	59	51	45	73
	Break-Out	47	55	54	50	54	47	40	33	60

PERFORMANCE CURVES - ACOUSTIC CHARACTERISTICS

- q_v : Airflow in m^3/h .
- p_{st} : Static pressure in Pa.
- P: Input power in W.
- SFP: Specific fan power in $W/m^3/s$ (blue curves).
- Performance data in accordance with ISO 5801 and AMCA 210-99 Standards.

CVAT/6-15000/710N 1,5kW

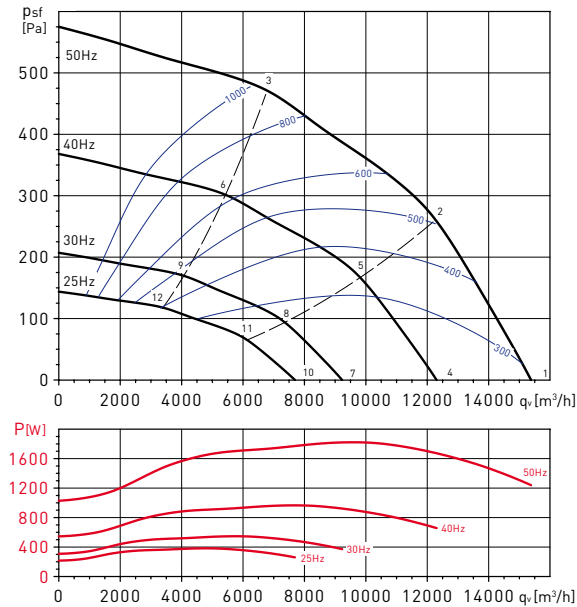

Working point	63	125	250	500	1000	2000	4000	8000	LwA	
1	Inlet	57	77	82	81	80	80	78	74	88
	Outlet	66	78	81	81	83	77	75	62	88
	Break-Out	51	63	71	66	68	63	60	57	74
2	Inlet	52	75	79	78	77	75	69	66	84
	Outlet	57	76	77	79	81	72	67	59	85
	Break-Out	45	61	68	63	65	58	51	48	71
3	Inlet	53	76	76	75	73	72	67	63	82
	Outlet	58	77	74	76	78	69	65	58	83
	Break-Out	46	63	65	60	61	54	49	46	69
4	Inlet	52	72	77	76	75	75	73	69	83
	Outlet	61	73	76	76	78	72	70	57	83
	Break-Out	46	58	66	61	63	58	55	52	69
5	Inlet	47	70	74	73	72	70	64	61	79
	Outlet	52	71	72	74	76	67	62	54	80
	Break-Out	40	56	63	58	60	53	47	43	66
6	Inlet	48	71	71	70	68	67	62	58	77
	Outlet	53	72	69	71	73	64	60	53	78
	Break-Out	41	58	60	55	56	49	44	41	64
7	Inlet	46	66	71	70	69	69	67	63	77
	Outlet	55	67	70	70	72	66	64	51	77
	Break-Out	39	52	60	55	57	52	49	46	63
8	Inlet	41	64	68	67	66	64	58	55	73
	Outlet	46	65	66	68	70	61	56	48	74
	Break-Out	34	50	57	52	54	46	40	37	60
9	Inlet	42	65	65	64	62	61	56	52	71
	Outlet	47	66	63	65	67	58	54	47	72
	Break-Out	35	52	54	49	50	43	38	35	58
10	Inlet	42	62	67	66	65	65	63	59	73
	Outlet	51	63	66	66	68	62	60	47	73
	Break-Out	35	48	56	51	53	48	45	42	59
11	Inlet	37	60	64	63	62	60	54	51	69
	Outlet	42	61	62	64	66	57	52	44	70
	Break-Out	30	46	53	48	50	42	36	33	56
12	Inlet	38	61	61	60	58	57	52	48	67
	Outlet	43	62	59	61	63	54	50	43	68
	Break-Out	31	48	50	45	46	39	34	31	54

DIMENSIONS (mm)

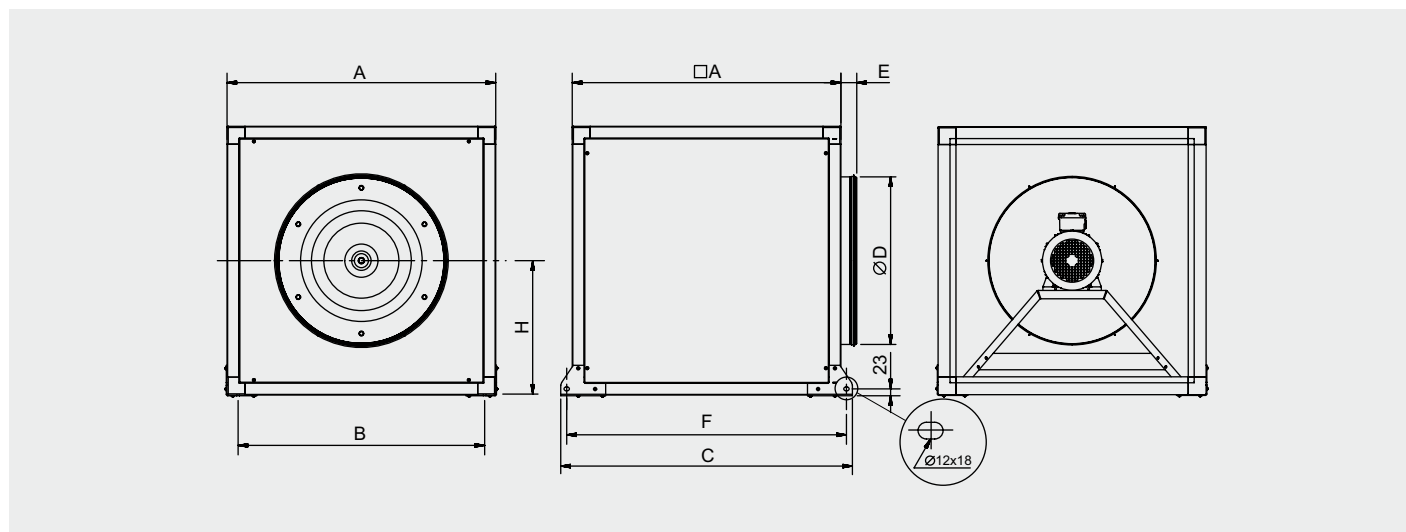

Model	A	B	C	D	E	F	H
CVAT/4-1400/250N 0,18	500	457	574	250	58	534	250
CVAT/4-2000/315N 0,18	500	457	574	315	58	534	250
CVAT/4-3000/355N 0,18	650	607	724	355	58	684	325
CVAT/4-4000/400N 0,37	650	607	724	400	58	684	325
CVAT/4-6000/450N 0,75	750	707	824	450	58	784	375
CVAT/4-9000/500N 1,1	800	757	874	500	58	834	400
CVAT/4-12000/560N 2,2	900	826	977	560	53	937	450
CVAT/4-16000/630N 3	1000	959	1077	630	53	1037	500
CVAT/6-15000/710N 1,5	1100	1059	1177	710	53	1137	550

MOUNTING ACCESSORIES

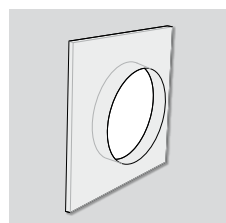

CDC
Circular duct connection panel to mount at the cabinet fan outlet.

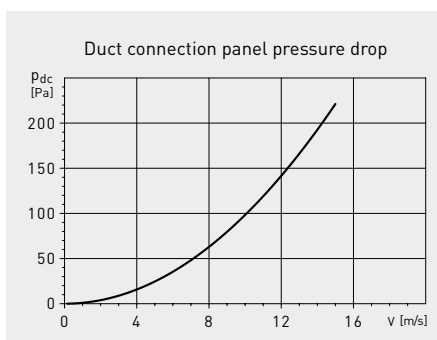

ACOPEL F400
Circular flexible connector.



CTI CVA
Outdoor cover
For outdoor installations.



KSE
Anti-vibration mounts.

ELECTRICAL ACCESSORIES



**AJUSTABLE
FREQUENCY DRIVE
VFKB**

Die cast aluminium
IP65 case.
Simple to operate.
Speed selection with
potentiometer.



**AJUSTABLE
FREQUENCY DRIVE
VFTM**

IP21 o IP54 models.
External display to
adjust parameters.



SC02-A
CO₂ and temperature
sensor.

SC02-AD
CO₂ and temperature
sensor, with display.

SCHT-AD
CO₂, temperature
and relative
humidity sensor
with display.

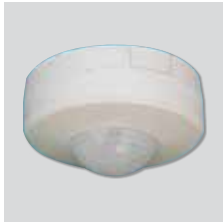

CPFL-S / CPFL-E
Presence detector.



TDP-S / TDP-D
Pressure sensor.

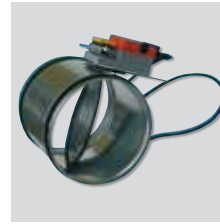

REMP
Motorised damper.