

RFTX 160 C

Description



The technical standard for explosion proof fans is called ATEX. C.A. Östberg was one of the first European fan producers to receive ATEX certification.

The RFTX range of fans complies with ATEX standards. The focus is on safety. Only top quality components are used.

RFTX provides a non sparking performance, powered by a high quality motor which is separated from the air stream. This makes RFTX a safe choice for a number of different applications within the industry. Seven models are available ranging from 0.08 to 0.5 m³/s.

Technical data

Parameter	Value	Unit
Voltage	400	V
Phase	3	~
Frequency	50	Hz
Power	590	W
Current	0,97	A
Speed	2740	r.p.m.
Max. temperature of transported air	40	°C
Max. temperature of transported air when speed controlled	40	°C
Sound pressure level at 3 m	61	dB(A)
Length	233	mm
Width	286	mm
Height	267	mm
Weight	9,6	kg
Enclosure class	55	IP
Insulation class, motor	F	

Diagrams

User point
Airflow [l/s] 140
Static pressure [Pa] 651
Work point
Airflow [l/s] 140
Static pressure [Pa] 651
Power [W] 297
Current [A] 0,749
Speed [r.p.m.] -
Efficiency [%] 0,309
SFP [kW/m ³ /s] 2,09
Voltage [V] 400

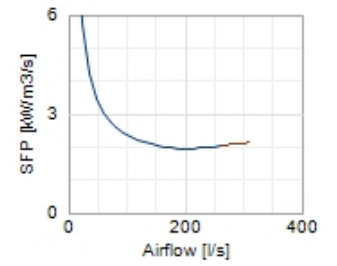
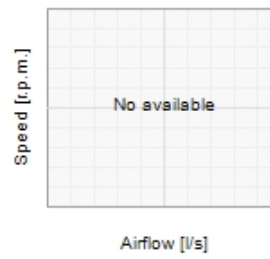
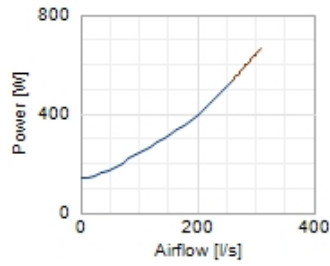
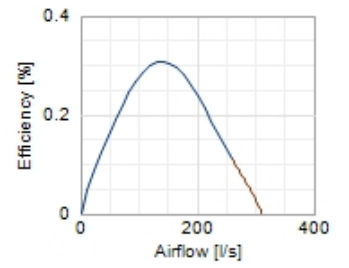
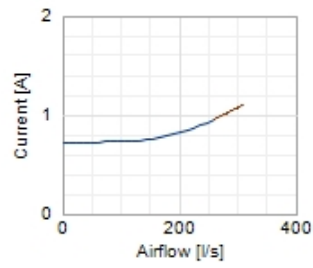
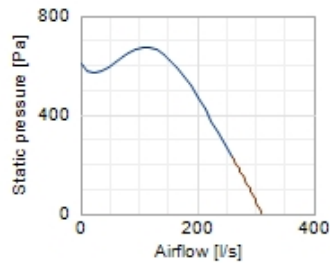

Sound

User point
Airflow [l/s] 116
Static pressure [Pa] 672
Work point
Airflow [l/s] 116
Static pressure [Pa] 672
Total pressure [Pa] 795
Power [W] 264
Current [A] 0,739
Speed [r.p.m.] -
Efficiency [%] 0,297
SFP [kW/m ³ /s] 2,23
Voltage [V] 400

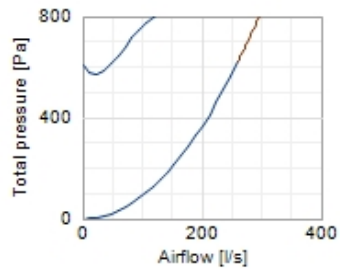
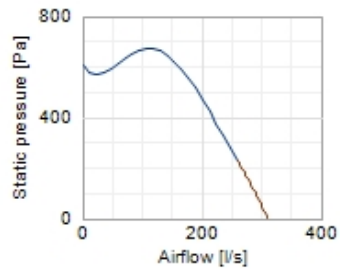

Distance: 3
Sound propagation: Hemispherical
Equivalent absorption area: 20

	Tot	63	125	250	500	1k	2k	4k	8k
Inlet Lw dB(A)	76	61	70	71	68	66	66	61	50
Outlet Lw dB(A)	76	64	67	70	70	67	68	63	57
Surrounding Lw dB(A)	67	33	34	50	54	60	63	61	53
Surrounding Lp dB(A)	60	26	27	44	47	53	57	55	46

Dimensions

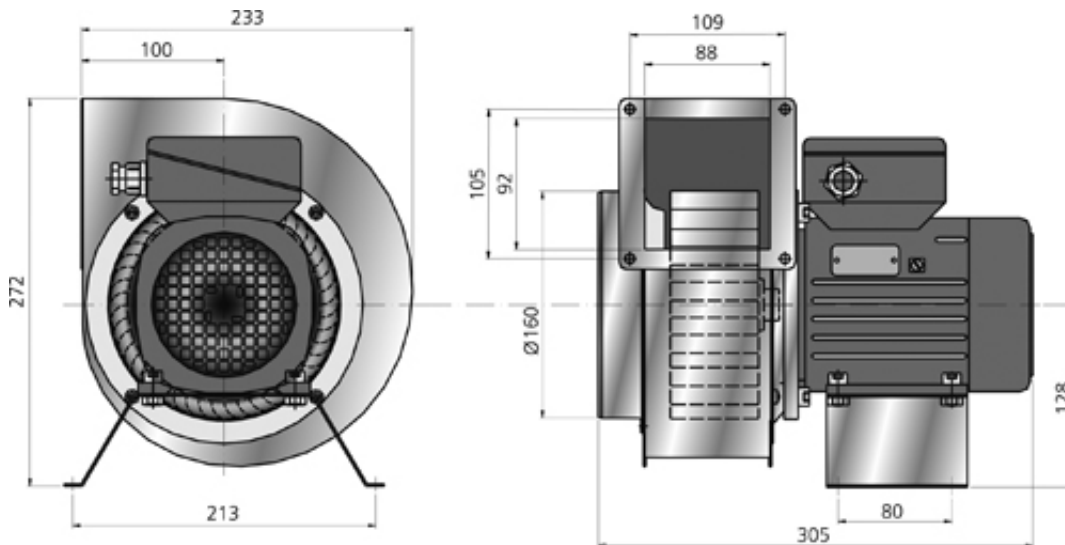

Electric accessory



Motor protection
0,63-1,0 A

Accessory



Outlet pipe 160
A/C

Documents

Directions for use

1270109_utg4_RFTX_sveng_low.pdf

EC Declarations

EC_Decl_1270109_utg3_RFTX_sveng.pdf

Product declarations

BVD10_u1_RFTX_RKX.pdf

ATEX Certificates

RFTX SP09ATEX3136X.pdf

IMPORTANT_INFORMATION_ATEX.pdf

ATEX_SP07ATEX7124 20130618.pdf