



Low profile in-line mixed flow duct explosion proof fans. TD-800 Ex is manufactured in antistatic plastic material. The others models are manufactured from sheet steel protected with black polyester paint coating. Detachable fan unit without demounting duct connections. Working temperature from -20 to +40°C.

Motors

Single phase 230V-50Hz.

IP44, Class B.

Explosion proof versions in accordance to ATEX 94/9/CE Directive.

For model 800:

- Increased safety Ⓜ II2G EExeIICT3
EC nr. LOM 08ATEX2052 X Supplement 2.

For models 1100 and 1200:

- Increased safety Ⓜ II2G EExeIICT3 Gb
EC nr. LOM 11ATEX2021 X Supplement 1.



Mixed flow impeller
Efficient performance mixed flow impeller.



External terminal box and ATEX capacitor, External terminal box, IP55, easy access, fireproof plastic V0.



Earth connection.

Specific applications



TECHNICAL CHARACTERISTICS

Model	Speed (rpm)	Maximum absorbed power (W)	Maximum absorbed current (A)	Airflow at free discharge (m ³ /h)	Operating temperature (°C)	Sound pressure level* (dB(A))			Ø Duct (mm)	Weight (kg)
						Inlet	Radiated	Outlet		
TD-800/200 ATEX	2450	130	0,54	1.020	-20/+40	53	43	55	200	5
TD-1100/250 ATEX	2630	197	0,81	1.130	-20/+40	59	46	65	250	20
TD-1200/315 ATEX	2600	170	0,71	1.320	-20/+40	56	44	59	315	25

* Radiated sound pressure level measured at 3 m in free field conditions with rigid ducts at the inlet and at the outlet, at point "B" of the curve.

DIMENSIONS (mm)

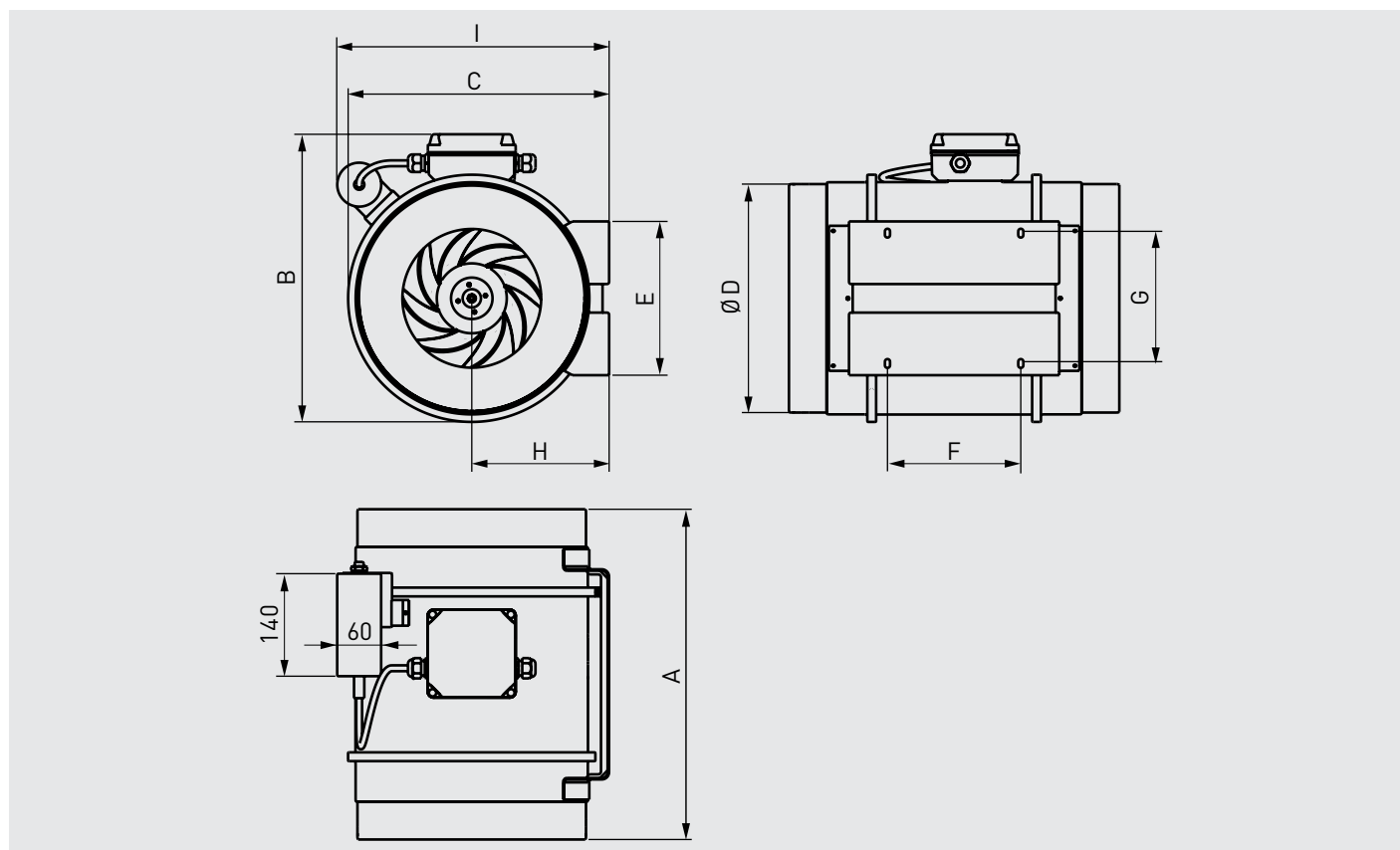

Model	A	B	C	Ø D	E	F	G	H	I
TD-800/200 ATEX	302	255	232,5	198	140	100	94	124	228,4
TD-1100/250 ATEX	386	324	291	248	168	145	140	155	339
TD-1200/315 ATEX	450	392	356	312	210	182	178	188	371

PERFORMANCE CURVES

- q_v : Air volume in m^3/h and m^3/s .
- p_{st} : Static pressure in mmWG and Pa.
- Dry air at 20°C and 760 mmHg.
- Performance data in accordance with ISO 5801 and AMCA 210-99 Standards.

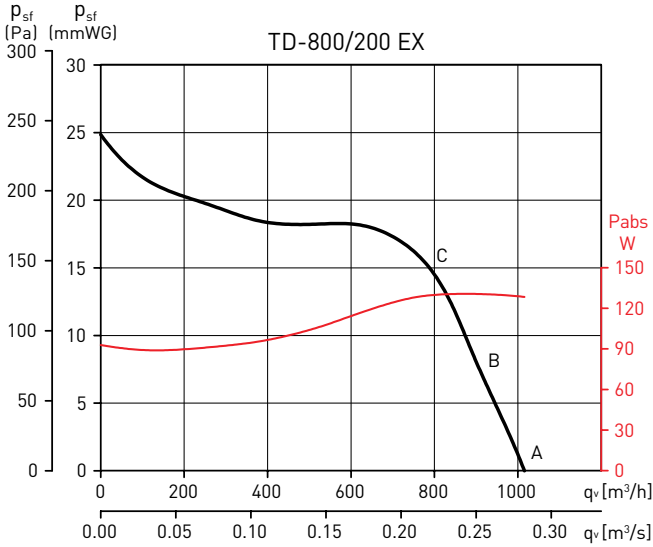

TD-800/200 EX		63	125	250	500	1000	2000	4000	8000	LwA
Inlet	A	27	43	53	61	69	69	65	56	73
	B	29	43	55	62	69	70	66	56	74
	C	39	49	69	71	74	70	63	55	78
Outlet	A	50	50	53	64	69	71	66	56	74
	B	44	45	54	66	70	71	67	57	75
	C	39	48	68	72	75	71	64	55	78
Radiated	A	7	38	37	44	58	61	52	39	63
	B	9	38	39	45	58	62	53	39	64
	C	19	44	53	54	63	62	50	38	66

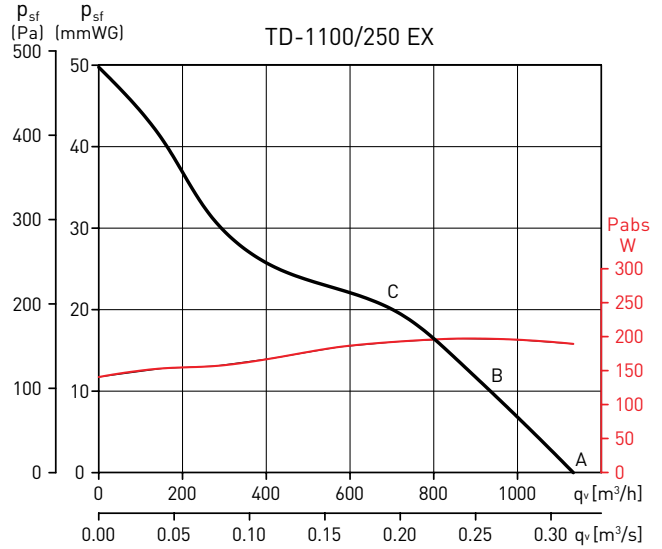

TD-1100/250 EX		63	125	250	500	1000	2000	4000	8000	LwA
Inlet	A	40	57	69	75	73	76	66	59	80
	B	40	58	70	75	72	74	65	57	79
	C	40	62	74	73	69	71	62	54	78
Outlet	A	54	55	70	80	82	81	72	62	86
	B	48	53	70	80	81	79	70	61	85
	C	41	56	72	80	78	76	68	58	84
Radiated	A	32	37	45	53	63	65	55	49	68
	B	32	38	46	53	62	63	54	47	66
	C	32	42	50	51	59	60	51	44	63

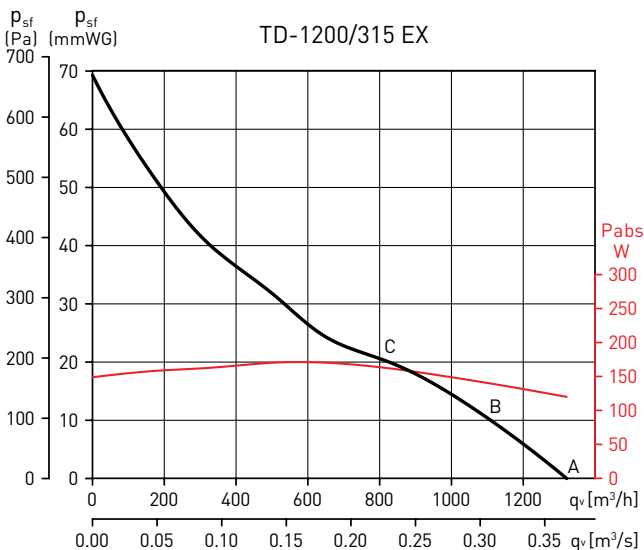

TD-1200/315 EX		63	125	250	500	1000	2000	4000	8000	LwA
Inlet	A	32	55	67	69	71	69	64	59	76
	B	34	58	70	70	71	69	64	59	76
	C	39	63	73	72	73	70	65	58	79
Outlet	A	47	55	67	72	74	72	67	62	78
	B	42	57	71	73	74	72	67	61	79
	C	39	60	74	75	75	74	68	60	81
Radiated	A	20	37	49	55	61	60	51	48	65
	B	22	40	52	56	61	60	51	48	65
	C	27	45	55	58	63	61	52	47	66

MOUNTING ACCESSORIES



MAR
Rectangular duct adapters.

Model	Type of TD-ATEX	Nominal dim. of ducting L x H (mm)
MAR - 800	800/200	315 x 200
MAR - 1000	1100/250	400 x 250
MAR - 2000	1200/315	500 x 315

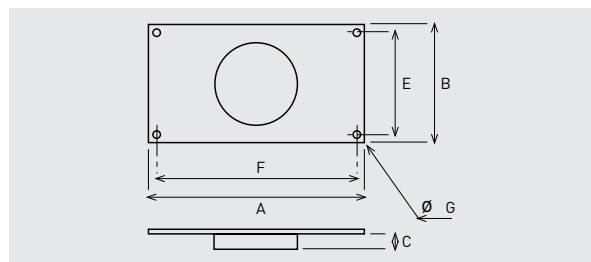

Model	A	B	C	E	F	ØG
MAR - 800	355	240	37	220	335	9
MAR - 1000	440	290	42	270	420	9
MAR - 2000	540	355	52	355	520	9

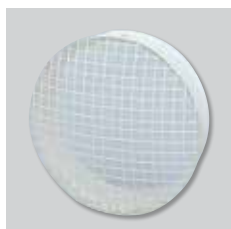

MRJ
Grilles mounted at the inlet or outlet of the fan, to prevent the entry of any foreign objects that could damage the fan.

Model	Type of TD-ATEX
MRJ - 800	800/200
MRJ - 1000	1100/250
MRJ - 2000	1200/315



ACOPEL EX
Proof explosion flexible connection.

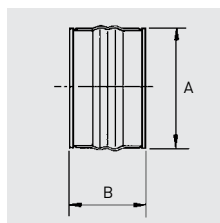

Model fan	Model connection	ØA	B
TD-800/200 EX	ACOPEL EX-200/160 N	200	160
TD-1100/250 EX	ACOPEL EX-250/160 N	250	160
TD-1200/315 EX	ACOPEL EX-315/160 N	315	160

For more information see Mounting accessories.